



FP1

# Titan Tube™

User Manual



# 1 CONTENTS

---

2	Package Contents.....	5
3	CE and FCC Conformity .....	5
4	Safety and Handling.....	6
4.1	Mounting Accessories .....	8
4.2	Battery .....	10
4.3	Battery Icon.....	10
4.4	Charging.....	11
4.5	AC and DMX Wiring.....	12
4.6	PowerBox Button and Status LED .....	13
5	Specification .....	14
6	Troubleshooting .....	15
7	Operation .....	16
7.1	Ship Mode .....	16
7.2	AsteraRGB Color Space.....	16
7.3	Ways to Control.....	17
7.4	Control By Infrared with ARC1 .....	17
7.5	Control by the AsteraApp™ .....	18
7.6	Control by Wireless DMX.....	18
7.7	Control by wired DMX .....	18
7.8	Control Panel.....	19
7.9	Blue Mode .....	19
7.10	Status Screen .....	20
7.11	Main Menu Options .....	21
7.12	Input Select .....	22
7.13	Select a Static Color.....	23
7.14	DMX Settings .....	24
7.15	Dimmer Curve.....	24
7.16	Runtime .....	25
7.17	Unpair CRMX.....	26
7.18	Standalone.....	27
7.19	AC Failure(Emergency Light) .....	29
7.20	DMX Failure .....	29
7.21	Info.....	30
7.22	Reset Settings.....	30
7.23	Adjust Color via the Color Palette Button.....	31
7.24	Adjust Brightness or Runtime via the Brightness Button .....	32
8	Using the Light with the AsteraApp™.....	33
8.1	Pair your Light with the AsteraApp™.....	33
8.2	Powerful Light Control .....	34
8.3	Change the Color.....	34
8.4	Create a Set.....	35
8.5	Targeting Lights.....	36
8.6	Changing The Effect.....	37
8.7	List of Effects.....	38
8.8	Chaser Effects in Depth .....	39
8.9	The Main Screen.....	40
8.10	Brightness.....	41
8.11	Runtime .....	42
8.12	Anti-Flicker .....	42
8.13	Theft Alarm .....	43
8.14	Enter and Leave Standby.....	44
8.15	DMX Settings .....	45
9	Menu Overview .....	46
10	DMX Profile Tables.....	47



1: RGB (PIXELS = 1; STROBE = OFF) .....47

2: RGBS (PIXELS = 1; STROBE = OFF) .....48

3: RGBAW (PIXEL = 1; STROBE = OFF) .....49

4: DIM RGB (PIXEL = 1; STROBE = OFF) .....50

5: DIM RGBW (PIXEL = 1; STROBE = OFF) .....51

6: DIM RGBAW (PIXEL = 1; STROBE = OFF) .....52

7: RGB CCT DIM IND (PIXEL = 1; STROBE = OFF) .....53

8: RGBS (PIXEL = 1; STROBE = SINGLE) .....54

9: RGBWS (PIXEL = 1; STROBE = SINGLE) .....55

10: RGBAWS (PIXEL = 1; STROBE = SINGLE) .....56

11: DIM RGBS (PIXEL = 1; STROBE = SINGLE) .....57

12: DIM RGBWS (PIXEL = 1; STROBE = SINGLE) .....58

13: DIM RGBAWS (PIXEL = 1; STROBE = SINGLE) .....59

14: RGB CCT DIM IND S (PIXEL = 1; STROBE = SINGLE) .....60

15: EFFECT MODE FIX .....61

16: EFFECT MODE RGB .....63

17: RGB.RGB. (PIXEL = 4; STROBE = OFF) .....65

18: RGB RGB (PIXEL = 4; STROBE = OFF) .....66

19: RGBW RGBW (PIXEL = 4; STROBE = OFF) .....67

20: RGBAW RGBAW (PIXEL = 4; STROBE = OFF) .....68

21: DIM RGB DIM RGB (PIXEL = 4; STROBE = OFF) .....69

22: DIM RGBW DIM RGBW (PIXEL = 4; STROBE = OFF) .....70

23: DIM RGBAW DIM RGBAW (PIXEL = 4; STROBE = OFF) .....71

24: RGB CCT DIM IND (PIXEL = 4; STROBE = OFF) .....72

25: RGB.RGBS (PIXEL = 4; STROBE = SINGLE) .....74

26: RGB RGB .. S (PIXEL = 4; STROBE = SINGLE) .....75

27: RGBW RGBW .. S (PIXEL = 4; STROBE = SINGLE) .....76

28: RGBAW RGBAW .. S (PIXEL = 4; STROBE = SINGLE) .....77

29: DIM RGB DIM RGB .. S (PIXEL = 4; STROBE = SINGLE) .....78

30: DIM RGBW DIM RGBW .. S (PIXEL = 4; STROBE = SINGLE) .....79

31: DIM RGBAW DIM RGBAW .. S (PIXEL = 4; STROBE = SINGLE) .....80

32: RGB CCT DIM IND S (PIXEL = 4; STROBE = SINGLE) .....81

33: RGBS RGBS (PIXEL = 4; STROBE = MULTIPLE) .....83

34: RGB RGB .. SS (PIXEL = 4; STROBE = MULTIPLE) .....84

35: RGBWS RGBWS (PIXEL = 4; STROBE = MULTIPLE) .....85

36: RGBAWS RGBAWS (PIXEL = 4; STROBE = MULTIPLE) .....86

37: DIM RGBS DIM RGBS (PIXEL = 4; STROBE = MULTIPLE) .....87

38: DIM RGBWS DIM RGBWS (PIXEL = 4; STROBE = MULTIPLE) .....88

39: DIM RGBAWS DIM RGBAWS (PIXEL = 4; STROBE = MULTIPLE) .....89

40: RGB CCT DIM IND S (PIXEL = 4; STROBE = MULTIPLE) .....90

41: RGB.RGB. (PIXEL = 16; STROBE = OFF) .....92

42: RGB RGB (PIXEL = 16; STROBE = OFF) .....94

43: RGBW RGBW (PIXEL = 16; STROBE = OFF) .....96

44: RGBAW RGBAW (PIXEL = 16; STROBE = OFF) .....98

45: DIM RGB DIM RGB (PIXEL = 16; STROBE = OFF) .....100

46: DIM RGBW DIM RGBW (PIXEL = 16; STROBE = OFF) .....102

47: DIM RGBAW DIM RGBAW (PIXEL = 16; STROBE = OFF) .....104

48: RGB CCT DIM IND (PIXEL = 16; STROBE = OFF) .....107

49: RGB.RGBS (PIXEL = 16; STROBE = SINGLE) .....113

50: RGB RGB .. S (PIXEL = 16; STROBE = SINGLE) .....115

51: RGBW RGBW .. S (PIXEL = 16; STROBE = SINGLE) .....117

52: RGBAW RGBAW (PIXEL = 16; STROBE = SINGLE) .....119

53: DIM RGB DIM RGB .. S (PIXEL = 16; STROBE = SINGLE) .....121

54: DIM RGBW DIM RGBW .. S (PIXEL = 16; STROBE = SINGLE) .....123

55: DIM RGBAW DIM RGBAW .. S (PIXEL = 16; STROBE = SINGLE) .....125

56: RGB CCT DIM IND S (PIXEL = 16; STROBE = SINGLE) .....128

57: RGBS RGBS (PIXEL = 16; STROBE = MULTIPLE) .....134

58: RGB RGB .. SS (PIXEL = 16; STROBE = MULTIPLE) .....138



59: RGBWS RGBWS (PIXEL = 16; STROBE = MULTIPLE) .....	142
60: RGBAWS RGBAWS (PIXEL = 16; STROBE = MULTIPLE) .....	146
61: DIM RGBS DIM RGBS (PIXEL = 16; STROBE = MULTIPLE) .....	150
62: DIM RGBWS DIM RGBWS (PIXEL = 16; STROBE = MULTIPLE) .....	154
63: DIM RGBAWS DIM RGBAWS (PIXEL = 16; STROBE = MULTIPLE) .....	158
64: RGB CCT DIM IND S (PIXEL = 16; STROBE = MULTIPLE) .....	163
LEE Color Gels .....	171
11 Version History .....	175



### **Contact Information**

Astera LED Technology GmbH

Stahlgruberring 36  
81829 Munich  
Germany

+49 89 2155253-0

### **Technical support**

Europe: +49 89 21552253-1

USA: +1 954 578 8881

Asia: +86 755 28237295

Email: [service@astera-led.com](mailto:service@astera-led.com)



## 2 PACKAGE CONTENTS

---

- Titan Tube
- Floorstand
- 2x Metal holder
- 2x Eye bolt
- Quick-start manual

## 3 CE AND FCC CONFORMITY

---

**This device complies with Part 15 of the FCC Rules. Operation is subject to the following two conditions:**  
**(1) this device may not cause harmful interference, and**  
**(2) this device must accept any interference received, including interference that may cause undesired operation.**

### FCC statement

Note: This equipment has been tested and found to comply with the limits for a Class B digital device, pursuant to part 15 of the FCC Rules. These limits are designed to provide reasonable protection against harmful interference in a residential installation. This equipment generates uses and can radiate radio frequency energy and, if not installed and used in accordance with the instructions, may cause harmful interference to radio communications. However, there is no guarantee that interference will not occur in a particular installation. If this equipment does cause harmful interference to radio or television reception, which can be determined by turning the equipment off and on, the user is encouraged to try to correct the interference by one or more of the following measures:

- Reorient or relocate the receiving antenna.
- Increase the separation between the equipment and receiver.
- Connect the equipment into an outlet on a circuit different from that to which the receiver is connected.
- Consult the dealer or an experienced radio/TV technician for help.

### EU Declaration of Conformity

These products comply with the RED (Radio Equipment Directive) of the European Union (2014/53/EC). This equipment meets the following conformance standards: ETSI EN 301 489-1 V1.8.1; ETSI EN 301 489-3 V1.4.1; ETSI EN 300 328 V1.8.1; EN 609 50.

## 4 SAFETY AND HANDLING

Before you operate this unit read the manual carefully. Always make sure to include the manual if you pass/rent/sell the unit to another user. Keep in mind that this manual cannot address all possible dangers and environments. Please use your own caution when operating. This product is for professional use only. It is not for household use.



- Do not operate the unit in areas of high temperature conditions or under direct sunlight. It will cause abnormal function or damage the product.
- Always use a suitable safety wire when mounting the light overhead.
- Connect the safety wire only to the intended safety mount.
- Always follow local safety requirements.



- Only qualified personnel may repair this product.
- Do not open the product housing.
- Do not apply power if the light is damaged.
- Do not submerge the light into any liquid.
- Do not replace LED light source by yourself.
- Caution, risk of electrical shock



- Do not directly look into the light.
- It can cause harm to your eyes.
- Do not look at the LEDs with a magnifying glass or any other optical instrument that may concentrate the light output.
- Use only Astera approved accessories to diffuse or modify the light beam.



- The exterior surfaces of the light can become hot, up to 70°C (158°F) during normal operation.
- Ensure that accidental physical contact with the device is impossible.
- Install only in ventilated locations.
- Do not cover the light.
- Allow all lights to cool before touching.
- Keep 0.3m (12in) from objects to be illuminated.

**LI-ION Battery:** A rechargeable lithium ion battery is built into this unit.



- Only authorized personal may service the battery.
- Do not place in fire or heat.
- Do not use or charge the light if it is damaged.
- Avoid bumping or plunging, it may cause fire or explosion.
- Never store the battery when fully drained.
- Always recharge immediately when empty.
- Make sure to fully charge all units before storing them.
- Partially charged batteries will lose capacity.
- Fully recharge every 6 months if not used.
- The battery may only be replaced with an original spare part from Astera.
- Follow applicable laws and regulations for transport, shipping, and disposal of batteries. For details on recycling lithium, lithium-phosphate, and lithium-ion batteries, please contact a government recycling agency or your waste-disposal service.



- **Always charge with the flight case open.**
- **It is recommended to charge at a temperature between 15°C and 35°C**
- **The light contains a lithium ion battery.**
- **Don't throw the unit into the garbage at the end of its lifetime.**
- **Make sure to dispose is according to your local ordinances and/or regulations, to avoid polluting the environment!**
- **The packaging is recyclable and can be disposed.**

## 4.1 MOUNTING ACCESSORIES

The Titan Tube offers a variety of mounting options via customized accessories.

### 4.1.1 Floorstand

For a quick vertical setup, the floorstand can be screwed onto the tube via one of its M5 threads. The floorstand can be folded together for a convenient transportation.

**Please note:** the M5 threads are not designed for several tubes to be screwed together to form one long tube element.

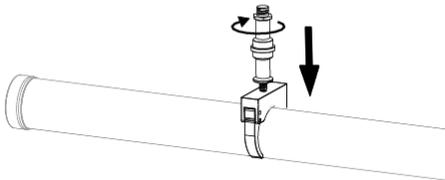
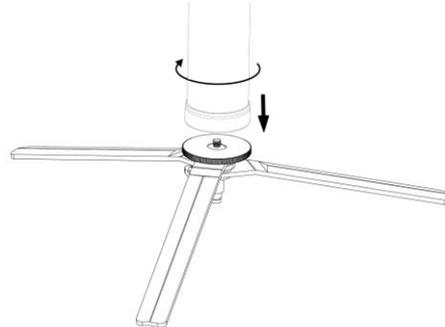

### 4.1.2 Holders

The silver Astera metal holders fit around the Titan Tube. To prevent them from opening, they can be locked in with metal pins.

The holders have a 1/4"-20 thread so that Astera's double-ended spigot (AX1-BLT) can attach the holder to a Manfrotto Super Clamp. Also, holders can be fixed with a screw to a wooden wall or board. Holders also have 2 M5 threads for the eyebolts mentioned below

### 4.1.3 Wing Plate

The Wing Plate is designed to attach two holders onto its surface. It can be mounted with just one of Astera's double-ended spigots.

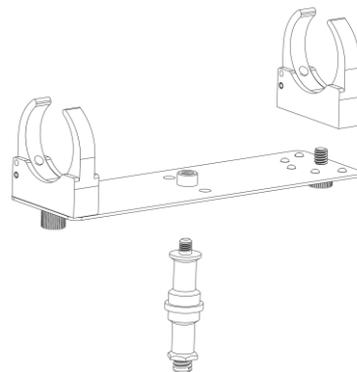
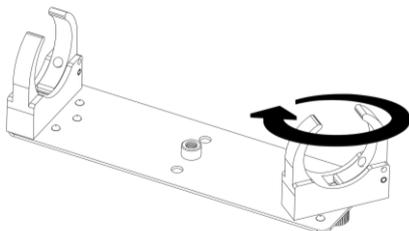

The holders on the Wing Plate can be aligned in parallel if one Wing Plate is used with one tube. In addition, the holders on the Wing Plate can be turned 45° or 90°. That way two tubes can be connected together in different angles.

#### 4.1.4 Eyebolts

Eyebolts can be screwed into the M5 threads of the Titan Tube or the holders. The eye bolts can be used with a safety wire when hanging a tube via holders above people's heads.

The eyebolts can also be used to suspend the tube but in this case a secondary point must be attached for safety (e.g. via a holder).

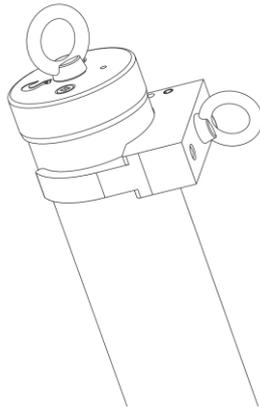

## 4.2 BATTERY

While running on battery, the light adjusts its output to meet the required minimum runtime. It can be set by the control panel (see chapter 7.16) or the AsteraApp™ between one and twenty hours.

The battery is specified to last for 300 full discharge cycles. Its runtime will have decreased to 70% by then. To increase the battery life, it is recommended to recharge as early as possible and not let the light run until the battery is fully discharged.

If operated below 20°C, the battery runtime may be slightly shorter than predicted. This is also true if the lights are stored for a long time at cold temperature right before they are used.

The light is constantly monitoring the LED temperature and dims down the brightness if it exceeds 65°C. That ensures a save and long-live operation but in a hot environment the brightness might be slightly lower.

**PLEASE NOTE:** Always store the lights with full battery.  
Depleted batteries must be recharged immediately, otherwise their performance will suffer.

**ATTENTION:** The battery may be only replaced with an original Astera replacement battery.

### 4.2.1 STANDBY

By using the AsteraApp™, the light can be set to a special standby mode.

In that mode, its output is switched off, the CRMX receiver is powered down and it enters a state of low power consumption.

A full battery will supply the Titan Tube roughly 20 days in standby mode.

To leave the standby mode press ENTER key or select Leave Standby mode NOW in the AsteraApp™.

## 4.3 BATTERY ICON

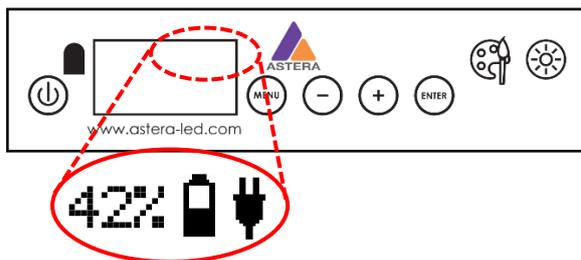

The display at the backside of the Titan Tube contains a battery icon which indicates the rough battery status. Next to it is a percentage that shows a more exact battery status.

While the light is connected to AC power, a power plug icon is shown next to the battery icon. If the battery is fully charged the battery icon will be filled with color and the power plug icon remains next to the battery icon.

The battery icon is shown in the top navigation and the Main Menu but not in the HIS and brightness menus. If you do not see the battery icon, press the Menu button once to return to the top navigation.

### 4.3.1 HOT icon

During operation with high power in an hot environment the tube might overheat. If this is the case the output will automatically be reduced until the tube has cooled down enough. A reduced output is indicated in the display by this icon:



## 4.4 CHARGING

Charge the light immediately after use and do not store lights with empty battery.

Lights can be charged with individual charger (FP1-CHR) or with Astera's PowerBox (FP1-PWB). If PowerBox and tubes are placed inside a charging case, make sure the case is open. It is recommended to charge the lights at an ambient temperature between 0°C and 35°C. A normal charge cycle will take three hours, but may take much longer if the light is hot.

The light is designed to be charged while powered off. If it is connected to AC and powered on, it may charge at reduced current if enough power is available and the battery temperature is below 45°C. If the battery temperature is above 45°C, charging stops completely until the battery has cooled down enough. If the battery temperature cools below 5°C charging also stops completely until the battery has warmed up enough.

The light has an automatic battery bypass switch, so it can safely be used wired for longer periods, this will not cause wear to the battery.

### Connecting a cable for charging:

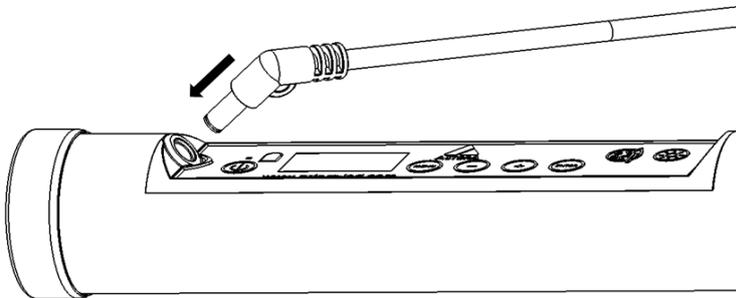

### Display messages during charging (only shown when light is powered off):

Charging... [=====] 50%	The battery is being charged.
Fully Charged [=====] 100%	The battery is fully charged. The LCD backlight will turn off.
TOO HOT: 60°C [=====] 50%	The battery cannot be charged, it is too hot. The charger will start once it has cooled down below 45°C.
TOO COLD: -5°C [=====] 50%	The battery cannot be charged, it is too cold. The charger will start once it has heated up to at least 5°C.
ERROR: #5 [=====] 50%	The battery cannot be charged, the error number should be mentioned to the service.

## 4.5 AC AND DMX WIRING

AC power and DMX data can be connected to the Titan Tube via Astera's PowerBox (FP1-PWB) and Astera's power/data combination cable (FP1-PWB-CAB). That way, the tubes can be wired for a longer show or permanent installation.

The PowerBox contains Neutrik True1 Powercon in and out sockets and 5-pin XLR in and out sockets so that several PowerBoxes can be daisy chained. In addition, data can also be applied to the PowerBox via its RJ45 Ethernet socket which accepts Art-Net DHCP, 2.X and 10.X as well as sACN. Its operation is explained in the next chapter.

The PowerBox has 10 DC sockets to wire 10 TitanTubes via power/data combination cables (sold separately, item code: FP1-PWB-CAB-5, -10, -15). 10 output means that a whole DMX universe of tubes can be connected (10 tubes x 16 pixels x 3 channels).

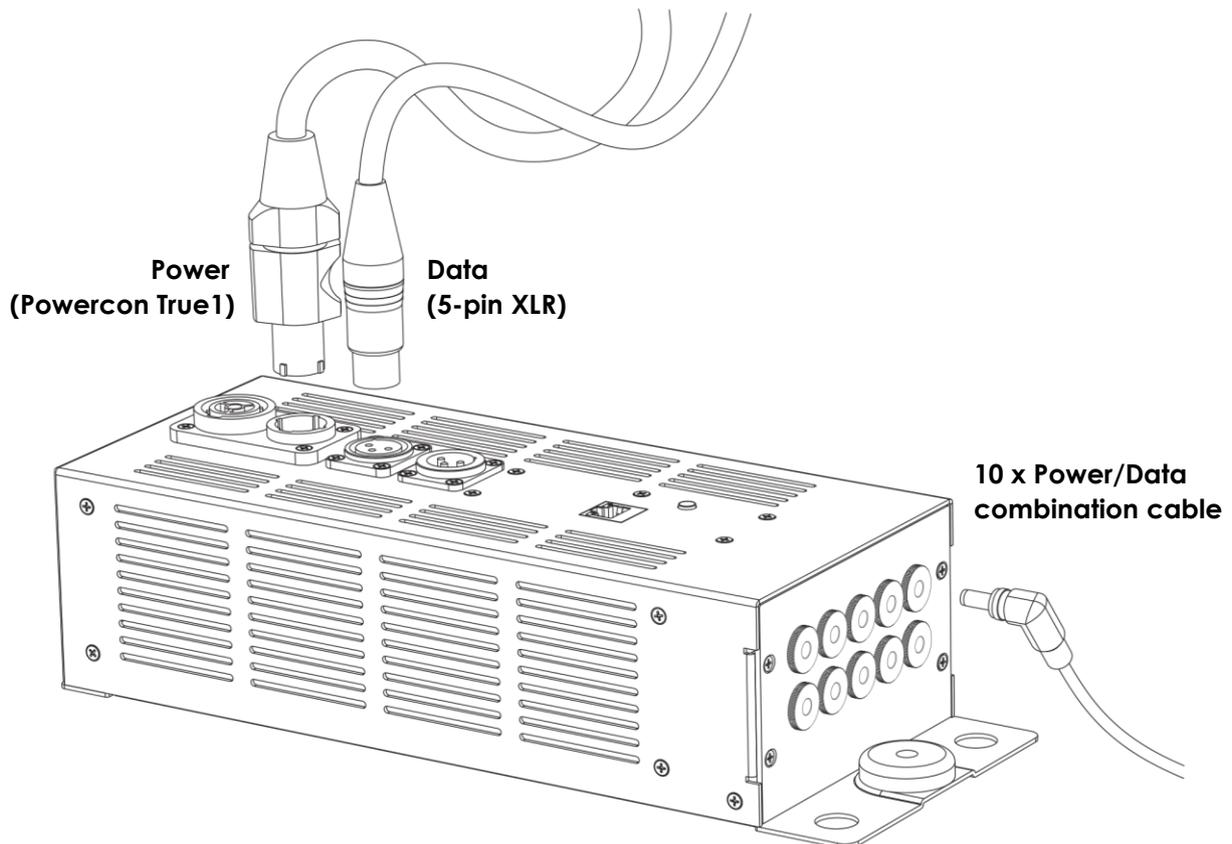

## 4.6 POWERBOX BUTTON AND STATUS LED

The PowerBox contains Powercon True1 in and out sockets as well as XLR in and out sockets. Also, there is an Ethernet socket which accepts Art-Net (DHCP, 2.X and 10.X) and sACN

### 4.6.1 Input

The inputs have the following priorities:

1. XLR
2. sACN
3. Art-Net

As long as XLR is received, sACN and Art-Net are deactivated.

While sACN or Art-Net are received, the DMX is also output on the XLR connector.

### 4.6.2 Status LED

The PowerBox has a status LED next to the Ethernet socket. If the LED is constantly on, this indicates that no DMX data is being received. If the status LED blinks slowly, this indicates that the PowerBox receives DMX.

The indicator LED can light up in different colors which indicate which data source is being received:

Blue	Art-Net DHCP
Magenta	Art-Net 2.X address
Green	Art-Net 10.X address
Yellow	sACN
Cyan	XLR

### 4.6.3 Button

Next to the indicator LED is a button. A single press on the button cycles between the different IP settings for Art-Net: DHCP, 2.x and 10.x.

### 4.6.4 Reset

The controller can be reset to restore the universe ID to 1 again.

Also, during each reset the controller tries to download a software update from the internet. To be successful, it must be connected to a LAN with DHCP.

The reset is done like this:

Hold the button down -> LED blinks blue -> hold still -> stops blue blinking after 4 sec.

Then the LEDs turn red for a moment and return to Art-Net 2.x again if no update was found.

If an update was found, the LED flashes green/blue until the update has been installed.



## 5 SPECIFICATION

<b>Total LED power:</b>	72W
<b>Maximum power draw:</b>	48W
<b>Illuminants:</b>	Red, Green, Blue, Mint, Amber LEDs
<b>Emittance @1m*:</b>	785 lx
<b>Luminous Flux*:</b>	2900 lm
<b>Beam Angle:</b>	120°
<b>Field Angle:</b>	180°
<b>CRI*:</b>	96-98 (3200 – 6500 K)
<b>TLCI*:</b>	96-98 (3200 – 6500 K)
<b>Input Voltage:</b>	24 V, 2 A
<b>Battery Runtime:</b>	up to 20hrs (seamless runtime)
<b>Wireless Module:</b>	EU: 868.0-869.7 MHz US: 902-928 MHz 2.4 GHz
<b>Operating Temperature:</b>	0°C – 40°C 32°F – 104°F
<b>Relative Humidity:</b>	0%-100%
<b>IP Rating:</b>	IP65 (with rubber plug in place)
<b>Dimensions:</b>	Ø42 x 1035mm Ø1.6" x H40.7"
<b>Weight:</b>	1.35 kg 3.0 lbs

\* Typical Values



## 6 TROUBLESHOOTING

---

### **The fixture does not turn on.**

The battery may be empty. Connect it to the AC and try again.

A new Titan Tube needs to be connected to AC power for a few seconds to disable its shipping mode.

### **The fixture turns on and the display is on, but the LEDs do not emit light.**

The fixture could be set to BLACKOUT mode, set to display black color or is operating in DMX mode and doesn't receive a valid signal. It is good practice to do a RESET SETTINGS (Chapter 7.22) between setups.

### **The fixture is not working correctly - it does not display the color or effect chosen.**

The fixture may still be operating under a previous setting. It is good practice to do a RESET SETTINGS (Chapter 7.22) between setups.

### **After completing a RESET SETTINGS, the fixture still cannot be controlled by AsteraApp™.**

Make sure the Radio PIN (Chapter 7.21) of the fixture and AsteraApp™ is the same.

### **The fixture does not run long enough on battery.**

The required RUNTIME can be set. By default, it is set to 5h. To achieve a greater battery runtime, set the RUNTIME to the required time (Chapter 7.16). Alternatively, program the - fixture to only display colors that use less power, such as Red, Green and Blue.

If the runtime is still too short, consider that it is reduced slightly if the battery is very cold.

### **The power cable is connected but the fixture is not charging.**

The battery may be fully charged. Refer to chapter 4.2.1 for more details. The fixture will only commence charging when its battery has a temperature of 45° or less. Turn the fixture off and let it cool down; once cold enough, it will start charging. If it still not charging, consult our website.

## 7 OPERATION

### 7.1 SHIP MODE

The Titan Tube is leaving the Astera factory in a special ship mode that allows it to be stored for a long time without damaging the battery. When using a Titan Tube for the first time, connect it to AC power for a few seconds to exit the ship mode. Otherwise it cannot be turned on.

### 7.2 ASTERARGB COLOR SPACE

The lights work with a specially optimized RGB color space, the AsteraRGB color space. It is designed to eliminate the need to control each color individually to display a certain color. Instead, the light calculates the optimum combination of all colors based on an RGB value. It considers each LED chip's temperature as well as an optimal color rendering.

Due to this, it is possible to reproduce colors with high accuracy. It is possible to calculate an AsteraRGB representation for any CIE color. The easiest way to do this is with the AsteraApp™:

- Go to the color picker and add a new favorite color
- Go to favorite colors and edit it

The dialog on the right will open.

It allows you to find AsteraRGB values for a certain color temperature. S-RGB or CIE1931 values can be calculated to AsteraRGB by pressing the corresponding buttons.

The primaries of the AsteraRGB are defined as:

Red		Green		Blue	
$x_R$	$y_R$	$x_G$	$y_G$	$x_B$	$y_B$
0.7079	0.2920	0.1750	0.7200	0.1566	0.0177

White Point	
$x$	$y$
0.4917	0.4878



The light also includes the Dynamic Powerboost feature. It ensures that colors that consume less electrical power are boosted slightly, while power-consuming colors are slightly compressed. This maximizes the brightness while maintaining the desired battery runtime.

While controlling with the AsteraApp™ or by the Control Panel, only RGB values can be set.

By DMX control, it is possible to control the Amber LEDs separately and also to emulate white channels. But it should be noted, that then temperature compensation is only available for Red, Green and Blue; all other colors will experience temperature drift, their brightness will not be constant.

### 7.3 WAYS TO CONTROL

The light can be controlled in several ways:



Use Astera's ARC1 infrared remote control, point it at individual lights and press the desired effect. Note that the IR sensor is on the back side next to the display.



The AsteraApp™ is an efficient way to quickly create a customized light show. It can group several lights together, address individual lights or groups of lights, and send complex effects with a user defined color palette to all lights in range. For additional information refer to chapter 8.



The light can be controlled via DMX or Ethernet cable when connected to the PowerBox (see chapter 4.5).



The light can also be controlled by wireless DMX, the built-in receiver is compatible with all LumenRadio\* CRMX transmitters as well as W-DMX™\* G2, G3, G4 and G4S transmitters (G4 and G4S in 2.4 GHz mode only).



Power the light on/off, set a static color or change its settings.

\*CRMX is a trademark of LumenRadio AB, W-DMX is a trademark of Wireless Solutions Sweden AB

### 7.4 CONTROL BY INFRARED WITH ARC1

The light can be controlled by the infrared remote control if:

- INPUT SELECT is set to AUTO or REMOTE CONTROL (refer to chapter 7.12).
- The light is currently NOT operated by DMX. If it is, only ON and OFF will work while INPUT SELECT is set to AUTO.



The ARC1 is very handy to switch several lights on or off at a time. The ARC1 can also accept configuration commands that are sent from the AsteraApp™ to a light by pressing the POWER ON button.



## 7.5 CONTROL BY THE ASTERAAPP™

Your light has a built in standalone engine. It can display static colors or replay a number of predefined effect patterns with a customizable color palette.

With the AsteraApp™ these effects can be created and be sent to the light by the built-in UHF receiver. The effects are just triggered and then each light replays it autonomously until it receives a new effect.

Lights can be grouped into sets. This way they can be controlled separately and effects can stretch over up to 128 lights.

Also, you can remotely adjust your lights settings, this eases DMX setup for example.

For more details about the AsteraApp refer to chapter 8.

## 7.6 CONTROL BY WIRELESS DMX

To pair your light to a CRMX or W-DMX™ transmitter, make sure that:

- Your light is not currently paired to a transmitter. To unpair it, refer to chapter 7.17.
- INPUT SELECT is either set to AUTO and the light is still in detect mode -or- INPUT SELECT is set to CRMX wireless DMX; for details refer to chapter 7.12.

Then press the button on your transmitter. After 10 seconds the light should be paired and show the appropriate status screen (chapter 7.10).

Titan Tubes can also be controlled by Astera's ART3 Transmitter which was sold from 2009 to 2015. If you prefer to use an Astera ART3 wireless transmitter, set INPUT SELECT to ART3 DMX and refer to the ART3's user manual for details.

### NOTE:

*If you experience difficulties pairing your light, it is recommended to set INPUT SELECT to CRMX wireless DMX first. This will make sure that the CRMX status screen is displayed.*

## 7.7 CONTROL BY WIRED DMX

The light can be wired to a DMX console. The light itself does not have an XLR socket, the data connection must be established through the Astera PowerBox (FP1-PWB).

Information about wiring of the PowerBox can be found in chapter 4.5.

If your light does not receive DMX data after being wired correctly, set its Input Select to Wired DMX (see chapter 7.12).

## 7.8 CONTROL PANEL



### Explanation of the buttons:

	When at top Navigation:	When inside Main Menu:
	Power on by holding button for 3 seconds Power off by shortly pressing button	
	Enter Main Menu	Back to previous Menu
	Reset Settings	Scroll down
	Change Input Select	Scroll up
	Set DMX Address	Choose / Confirm
	Adjust color (see chapter 7.23 for details)	
	Change brightness intensity or runtime (see chapter 7.24 for details)	

## 7.9 BLUE MODE

Blue mode is needed to pair your light with the AsteraApp. To enter Blue Mode, hold down the POWER button for 3 seconds while the light is switched on. It will start to flicker blue.



## 7.10 STATUS SCREEN

The status screen is shown after power up. The light also returns to the status screen if no keys are pressed for three minutes.

It shows:

- In the FIRST line what input is currently active
- In the SECOND line the current DMX and SET address

<pre>INPUT: DETECTING SET: 001  DMX: 001</pre>	INPUT SELECT is set to AUTO and the light did not yet latch to one input source.
<pre>APP CONTROL SET: 001  DMX: 001</pre>	The light is latched to APP CONTROL mode.
<pre>STANDALONE SET: 001  DMX: 001</pre>	INPUT SELECT is set to STANDALONE. The light can no longer be controlled by any wireless signal.
<pre>CRMX: SIGNAL 99% SET: 001  DMX: 001</pre>	The light is latched to CRMX mode.
<pre>ART3: NO LINK SET: 001  DMX: 001</pre>	The light is latched to ART3 DMX mode.
<pre>EMERGENCY LIGHT SET: 001  DMX: 001</pre>	Emergency light mode can be active because either AC FAIL or DMX FAIL being set to EMERGENCY LIGHT.
<pre>STANDBY SET: 001  DMX: 001</pre>	The standby mode saves power; the light is off and waiting for a "leave standby" command received by the AsteraApp™.
<pre>ALARM DO NOT STEAL THI</pre>	Theft alarm is active.
<pre>ACCEPT CONFIG ? SET: 001  DMX: 001</pre>	If the AsteraApp is asking to "tap a light" and this is shown, press the ENTER key shortly to accept. Alternatively you can use an ARC1 infrared remote, aim it at the light and press POWER ON to accept the setting.



## 7.11 MAIN MENU OPTIONS

The main menu can be entered from the status screen by pressing MENU or +. To cycle between the main menu entries, press the + or – keys. Pressing MENU again will go back to the status screen.

Main menu: INPUT SELECT	Used to change the input source or set it to AUTO.
Main menu: STATIC COLOR	Entering this menu resets all STANDALONE settings to default and makes the light display a static color.
Main menu: DMX ADDRESS	Set the DMX address.
Main menu: DMX SETTINGS	Set the DMX parameters.
Main menu: UNPAIR CRMX	Unpair from a CRMX or W-DMX™ transmitter.
Main menu: RUNTIME	Set the lights runtime on battery in hours.
Main menu: STANDALONE	Set parameters of the standalone engine.
Main menu: AC FAILURE	The light can react to the loss of AC power input.
Main menu: INFO	Information about the light: Radio PIN, firmware version, battery status, ect.
Main menu: RESET SETTINGS	Reset all user settings to default. Should be done after each usage to ensure consistent behavior. The Radio PIN is NOT reset.

## 7.12 INPUT SELECT

The light accepts several input sources. By default, it is set to AUTO. In this mode, it listens to all sources, and the first source that becomes active is latched. Once a source is latched, the light will not listen to any other source anymore.

This latched source is cleared by powering down the light or changing the INPUT SELECT manually.

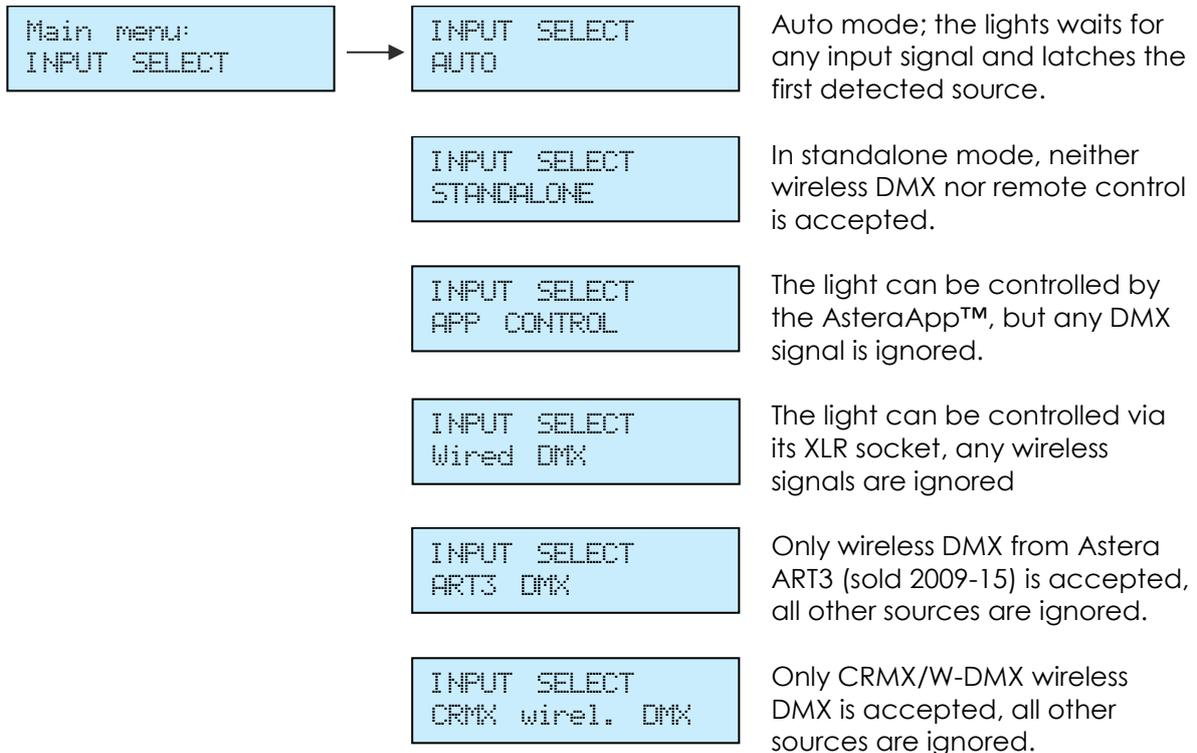

The following table shows what sources are accepted for each setting:

Source SELECT \ INPUT	Auto, none latched	Auto, Standalone latched	Auto, App control latched	Auto, Astera wirel. DMX latched	Autfp, CRMX wirel. DMX latched	STANDALONE	APP CONTROL	ART3 DMX	CRMX wirel. DMX	Wired DMX
AsteraApp™: change colors	•		•				•			
AsteraApp™: STANDBY, RUNTIME, ALARM	•	•	•	•	•		•			
AsteraApp™: DMX Settings	•	•	•	•	•		•	•	•	•
ART3 DMX	•			•				•		
CRMX Wireless DMX	•				•				•	•
Wired DMX	•				•				•	•
Infrared Remote	•	•	•	•	•		•			
The Light's Control Panel	•	•	•	•	•	•	•	•	•	•

**HINT:**

To avoid the light automatically latching onto CRMX while you want to control it by remote control, please do UNPAIR CRMX (chapter 7.17). As soon as the remote control is latched, the CRMX receiver will no longer accept pairing requests.

## 7.13 SELECT A STATIC COLOR

To make the light show a static color, enter this menu. Immediately when it's entered, all previous STANDALONE settings are cleared to default and the INPUT SELECT is latched to STANDALONE. This is valid until the next power-up only. To make sure the light also shows a static color after the next power up, set INPUT SELECT to STANDALONE and not AUTO.

You can also change a static color by pressing the color pallet button twice

```
Main menu:
STATIC COLOR
```



```
Static Color:
RED
```



```
Static Color:
6500K
```

```
Static Color:
INDEX COLOR
```

```
Static Color:
CUSTOM COLOR
```

A number of predefined colors are available while scrolling through the menu. See below for a full table.

In the INDEX COLOR menu, LEE color gels can be selected. The list of LEE color gels on page 55.

To set a color by its red, green and blue value, enter here.

### 7.13.1 Predefined Colors

Color	Red	Green	Blue
RED	255	0	0
ORANGE	255	107	0
YELLOW	255	160	18
GREEN	0	255	0
CYAN	0	255	224
BLUE	0	0	255
VIOLET	127	84	255
PINK	255	53	119
BLACK	0	0	0
2700K	255	166	70
3200K	255	178	89
4000K	255	193	115
5500K	255	211	150
6500K	255	219	167

## 7.14 DMX SETTINGS

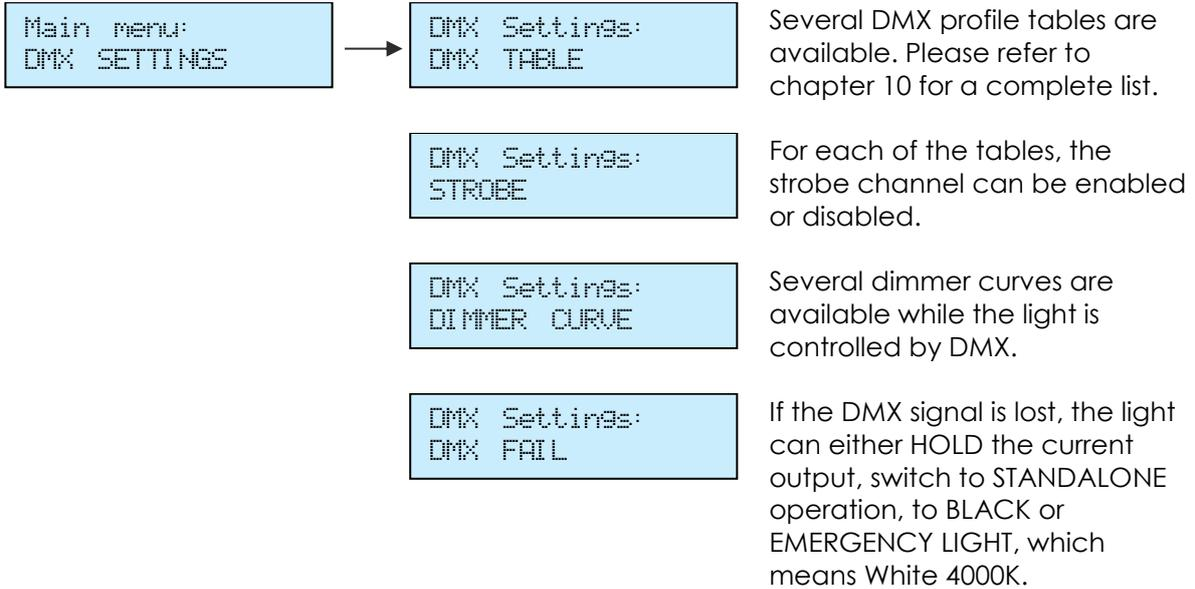

## 7.15 DIMMER CURVE

The dimmer curve sets how the light responds to intensity levels and changes. Most important, setting the right dimmer curve avoids stepy dimming response.

Several curves are available. By default, the "STANDARD" curve is active.

Name	Intended use	Features
Curve: STANDARD	Good compromise between response and smoothness	Fits most applications
Curve: HALOGEN	When slow and smooth dimming is required	Very smooth response, emulating a halogen light
Curve: THEATER	For theater stages	Very smooth response and increased dynamics. Some colors are darker.
Curve: TV	For TV sets and shows	Faster but still smooth dimming. Less blue light due to white point of 6500K. Less blue light. Increased dynamics. Some colors are darker.
Curve: FAST	For Pixel mapping and similar applications	Totally unfiltered response

## 7.16 RUNTIME

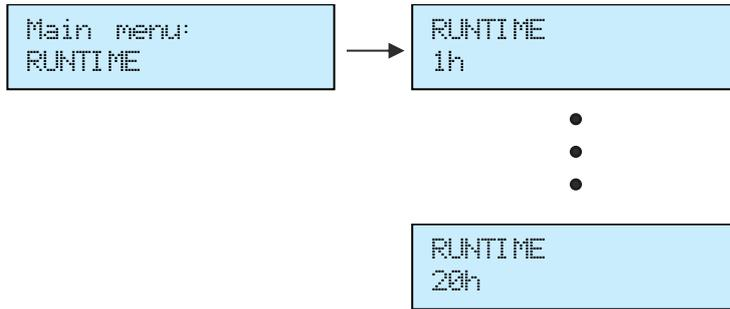

The light is able to adjust its power to meet a certain runtime on battery. The runtime is always calculated for a full battery.

### EXAMPLE:

*If the light is required to light during an eight-hour event, and one hour of setup time is scheduled, then the runtime should be set to nine hours immediately after the first power up.*

### NOTE:

Please note, that the light should not be stored below 20°C before an event, otherwise the runtime might be shorter than calculated.

The runtime feature is always active, even when the light is connected to AC power.

More details on the built-in battery can be found at chapter 4.2.

For additional power-savings refer to the AsteraApp™ manual.

## 7.17 UNPAIR CRMX

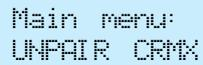
A screenshot of a light blue rectangular menu box with a black border. The text inside is in a monospaced font and reads "Main menu:" on the first line and "UNPAIR CRMX" on the second line.

Once your light is paired to a CRMX or W-DMX™ transmitter, it cannot be paired to another one until it is unpaired. This can be either done by using the button on the transmitter that is currently paired or on the light directly.

If you wish to unpair your CRMX wireless DMX receiver from a Lumen Radio or W-DMX™ transmitter, go to UNPAIR CRMX and press enter.

### **NOTE:**

*The CRMX receiver is only powered while INPUT SELECT is:*

- *set to CRMX wireless DMX*
- *or AUTO and either CRMX is latched or no source is latched yet.*

*For details in INPUT SELECT refer to chapter 7.12.*

## 7.18 STANDALONE

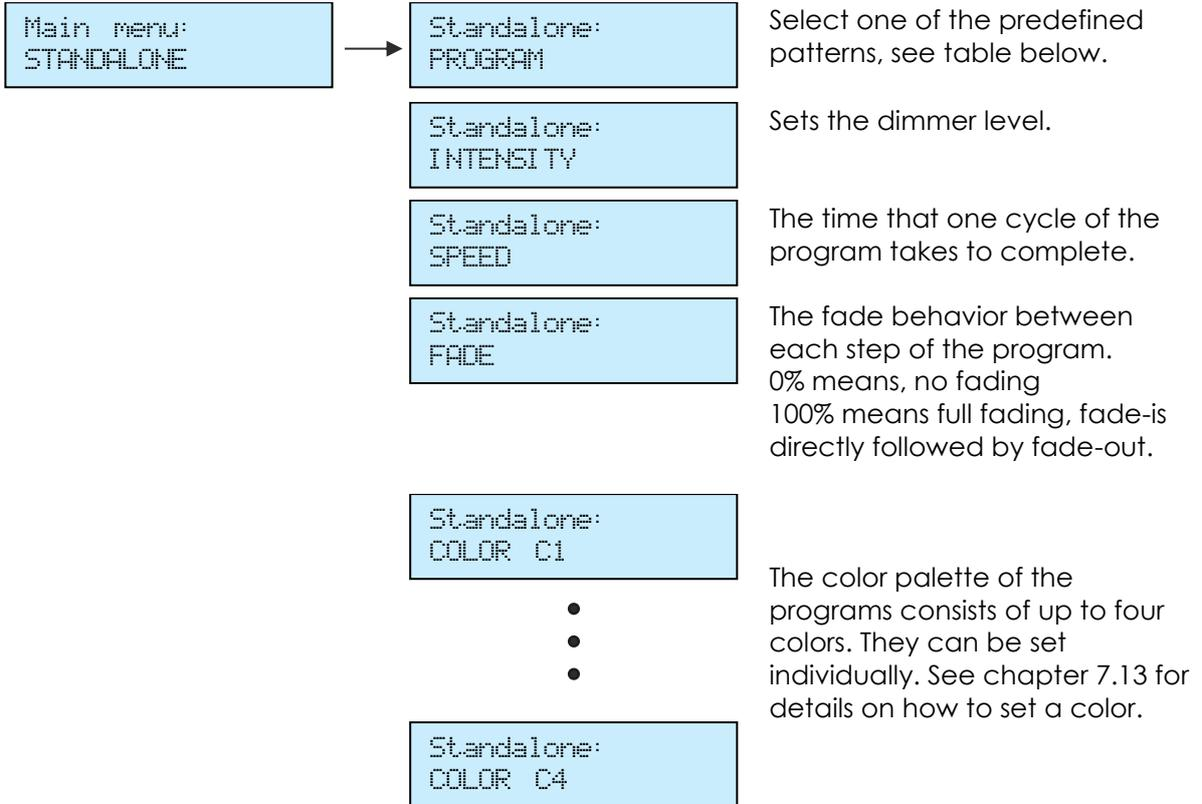

### 7.18.1 Predefined Programs

The predefined programs may use more than one pixel. To display these effects properly with your light, it is first necessary to group them into Flow-Sets and control them by the AsteraApp™ (see chapter 8.4).

If several lights are grouped into a Flow-Set, they form a virtual big light with several pixels.

Name	Pattern
<b>ONE COLOR STATIC</b>	A static color is displayed on the whole virtual light.
<b>TWO COLOR STATIC</b>	The virtual light is split into two halves and two colors are displayed.
<b>THREE COLOR STATIC</b>	The virtual light is split into three parts and three colors are displayed.
<b>FOUR COLOR STATIC</b>	The virtual light is split into four parts and four colors are displayed.
<b>ONE COLOR FADE</b>	For all FADE programs, the whole color palette of four colors is used. Those colors are faded in and out one by one. Here, the whole virtual light shows the same color.
<b>TWO COLOR FADE</b>	The virtual light is split and shows two colors at a time.
<b>THREE COLOR FADE</b>	The virtual light is split and shows three colors at a time.
<b>FOUR COLOR FADE</b>	The virtual light is split and shows four colors at a time.
<b>SIMPLE RUNNING</b>	A running light; the background and the running pixels color can be set.
<b>DOUBLE RUNNING</b>	Two pixels are running in opposite direction.
<b>TWO COL RUNNING</b>	The two pixels are of different color even.
<b>FLAG RUNNING</b>	A three color flag is running over the background color.
<b>DOUBLE FLAG RUNNING</b>	Two flags are running over background in opposite direction.
<b>SPIRAL 4 COLORS</b>	The color is changed pixel by pixel. All four colors are used one after the other.
<b>SPIRAL 2 COLORS</b>	The color changes between color 1 and 2 from the outside to the inside, pixel by pixel.
<b>RAINBOW</b>	A rainbow effect is displayed.
<b>FIRE</b>	The fire effect is a random flicker between two colors, background and flickering color.

#### NOTE:

*It is highly recommended to check out the effects editor of the AsteraApp™ to get a better understanding of how those programs work. Also, many programs look similar if the lamp is NOT grouped into a Flow-Set.*

### 7.19 AC FAILURE(EMERGENCY LIGHT)

The light can react to the loss of AC power in several ways. As soon as AC is present again, the light resumes normal operation.

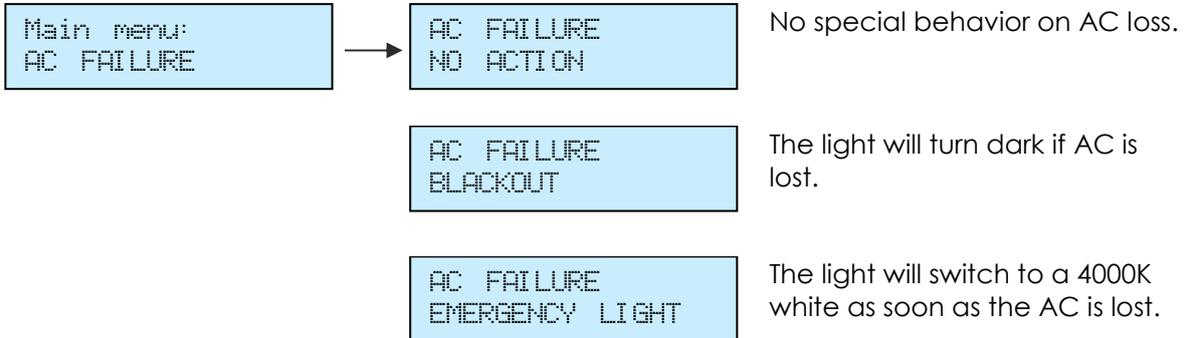

### 7.20 DMX FAILURE

When in CRMX Wireless DMX mode, XLR DMX mode or ART3 DMX mode the light can react to the loss of a DMX signal in several ways. As soon as a DMX signal is present again, the light resumes normal operation.

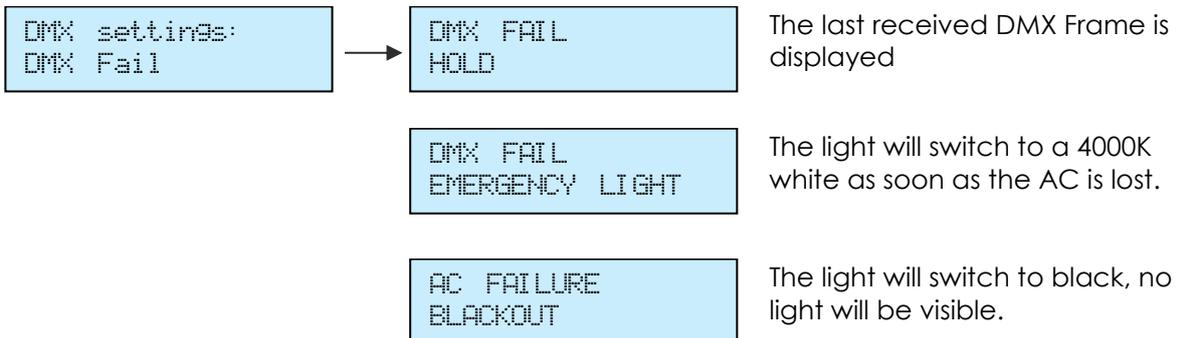

## 7.21 INFO

Main menu: INFO	Radio PIN: 0000	Set the Radio PIN. To change the PIN, press ENTER. Adjust each digit with the + and – keys, cycle through the digits with the MENU key. When finished, press ENTER again.
	AX1 Compatibility ENABLED	Enable to match color and brightness of your Titan Tube to AX1 Pixeltubes so that they can be used side by side.
	Serial number: 000-00000 43xx	Tells the serial number of the light and the CPU type (43xx).
	Firmware version 5.2.20.U HW001	The firmware version and hardware version of the light.
	Power-on hours: 00001h	The hour-counter is counting up as long as the light is powered up. It does not count if the light is powered off and charging.
	RF link: -36.0dBm -0.0ppm	While the light is receiving an UHF signal, this tells the signal strength and deviation.
	CRMX Version: V1.0.5.0	Shows the firmware of the built-in LumenRadio CRMX chip
	Battery state: 100%	The current charging state of the battery in percent.
	Battery Cycles: 003	Shows how many battery cycles the built-in battery has passed already
	Calibration: 2015-04-20-0001	Gives information about the LED calibration stored in the light, for service reference only.

## 7.22 RESET SETTINGS

Main menu: RESET SETTINGS	ARE YOU SURE? NO YES	Return the light to the default settings. This may be done before each use to start from a known point. The Radio PIN and the CRMX pairing stay.
------------------------------	-------------------------	--

### HINT

*It is highly recommended to reset the light's settings after each event to ensure a clear start for the next usage.*

## 7.23 ADJUST COLOR VIA THE COLOR PALETTE BUTTON

The color palette button on the Titan Tubes's keyfoil offers the possibility to adjust the color of the tube in several ways.

If the Color Palette button is pressed once it will show the HSI screen shown blow. To jump between lines, press the Enter button. To edit a value, press + or – button.

```
CCT : 1750 K
Green : 0.00
Hue : 360
Sat : 100%
```

**Color Temperature** is selected.

You can set the color temperature of your tube from 1,750 to 20,000 Kelvin.

```
CCT : 1750 K
Green : 0.00
Hue : 360
Sat : 100%
```

**Green / Magenta Correction** is selected.

You can adjust the displayed color by adding or subtracting the amount of green to reduce post-production work. This is designed for white tones, not for colors.

```
CCT : 1750 K
Green : 0.00
Hue : 360
Sat : 100%
```

**Hue** is selected.

Set a hue (color appearance) from 0 to 360

```
CCT : 1750 K
Green : 0.00
Hue : 360
Sat : 100%
```

**Saturation** is selected.

You can adjust how much of the selected Hue you want to mix to the selected Color Temperature.

Press the Color Palette button a second time to reach the static color screen shown below.

```
Static Color:
Red
```

Press + or – buttons to select a basic static color

Press the Color Palette button a third time to reach the filter gel screen shown below. To jump between the second and third line, press the Enter button. To edit a value, press + or – button.

```
Color Gel:
Lee Daylight
071
Tokyo Blue
```

**Change between gel types.**

You can change between Lee\* filters with daylight or tungsten lightsource and Rosco\* filters with daylight or tungsten lightsource.

```
Color Gel:
Lee Daylight
071
Tokyo Blue
```

**Change between gel numbers**

Browse through gels. The selected line shows their number while the line below shows the corresponding gel name.

Once the Color Palette button is pressed the selected values will be displayed on your tube immediately. Input Select will be changed to Standalone. If the Input Select was set to anything other than Auto or Standalone, pressing the Color Palette Button has no effect.

\*LEE is a registered trademark of Panavision International, L.P.

\*Rosco is a registered trademark of Rosco Laboratories, Inc

## 7.24 ADJUST BRIGHTNESS OR RUNTIME VIA THE BRIGHTNESS BUTTON

The brightness button on the Titan Tube's keyfoil offers the possibility to quickly adjust the brightness or runtime of the tube.

Once the Brightness button is pressed it will show the below screens. To jump between lines, press the Enter button. To edit a value, press + or – button.

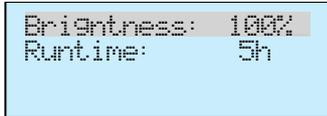
A screenshot of a monochrome display showing two lines of text: "Brightness: 100%" and "Runtime: 5h". The "100%" and "5h" are highlighted with a light blue background.

### **Brightness is selected.**

Set the total brightness of this tube from 0% to 100%.

A screenshot of a monochrome display showing two lines of text: "Brightness: 100%" and "Runtime: 5h". The "5h" is highlighted with a light blue background.

### **Runtime** is selected.

Change the seamless runtime of the tube from maximum brightness up to 20h. Additional information about runtime can be found in chapter 7.16.

Once the Brightness button is pressed the selected values will be displayed on your tube immediately. Input Select will be changed to Standalone. If the Input Select was set to anything other than Auto or Standalone, pressing the Color Palette Button has no effect.

## 8 USING THE LIGHT WITH THE ASTERAAPP™

The buttons of the Titan Tube allow a basic operation of the light. To gain full control over all features, the AsteraApp™ should be used.

The AsteraApp™ is an efficient way to quickly create a customized light show. It can group several lights together, address individual lights or groups of lights, and send complex effects with a user defined color palette to all lights in range.

Additionally, it can be used to adjust the lights settings remotely.

The AsteraBox™ is needed to interface your Android device with the lights. It communicates to the Android or iOS device by Bluetooth and controls the lights by UHF.

### 8.1 PAIR YOUR LIGHT WITH THE ASTERAAPP™

The connection is secured by a 4 digit Radio PIN. Only if the lights PIN matches the AsteraApp™ PIN, lights are controllable.

The pairing process transmits the radio pin from the app to the light and stores it there.

1. Choose a unique Radio PIN in the app.
2. Switch the light into blue mode, see chapter 7.9.
3. Press the “Pair with Lights” button in the AsteraApp™.

**NOTE:**

Alternatively, you can set the Radio PIN manually at the Control Panel of the light. Refer to chapter 7.21 for details.

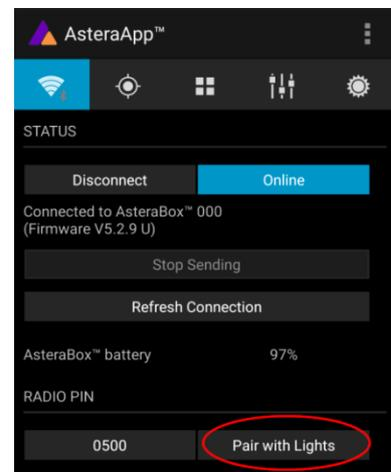

## 8.2 POWERFUL LIGHT CONTROL

Your light has a built in standalone engine. It can display static colors or replay a number of predefined effect patterns with a customizable color palette.

With the AsteraApp™ these effects can be created and be sent to the light by the built-in UHF receiver. The effects are just triggered and then each light replays them autonomously until a new effect is sent.

Lights can be grouped into sets. This way they can be controlled separately and also effects can stretch over up to 32 lights.

## 8.3 CHANGE THE COLOR



On the AsteraApp™ main screen, press “Just Red”.

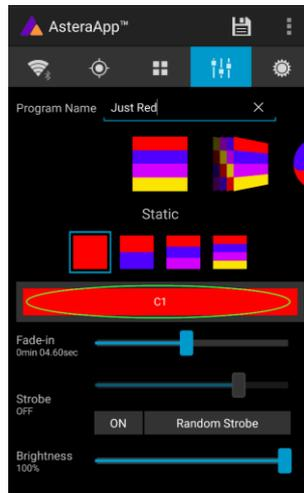

Once in the editor, press “C1”.



Now the lights color can be changed.

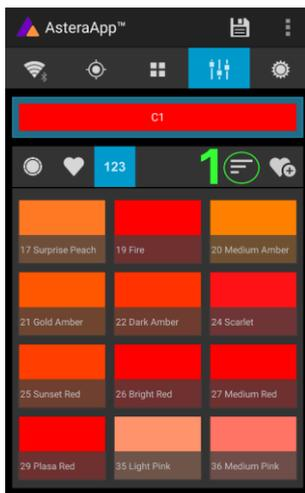

The “123” button offers common color gels. Hit the sort button to sort by color or number (1).

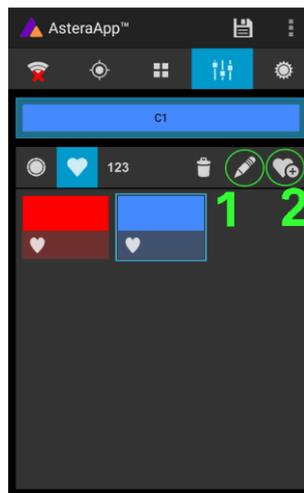

To add a color to the favorites, press (2). To edit an existing favorite color, select it and press the pen (1).



The editor will open. RGB values can be adjusted directly. Also a color temperature can be converted to RGB.

## 8.4 CREATE A SET

Before the more powerful effects can be reviewed, it is recommended to create a Flow-Set first.

Each light can be assigned to one set. Two types of sets are available:

### 8.4.1 SYNC SET

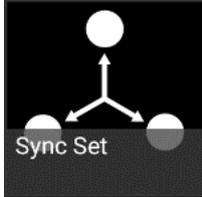

All lights that are assigned to a Sync-Set can be controlled together. They will do exactly the same.

#### CREATE A SYNC-SET:

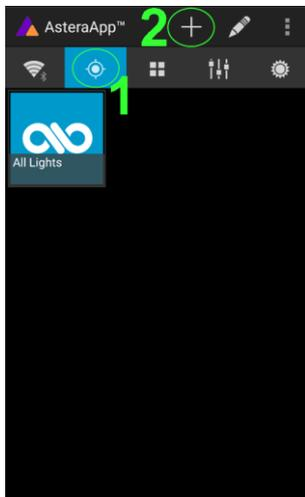

On the AsteraApp™ main screen, first press the Targets button (1) and then the "+" sign (2) to add a new target.

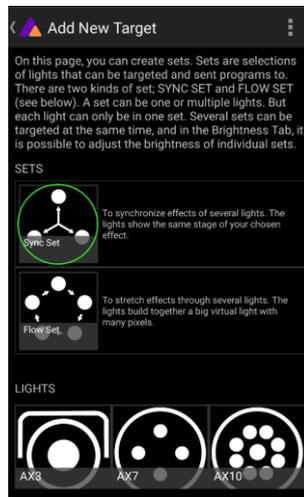

Choose "Sync-Set".

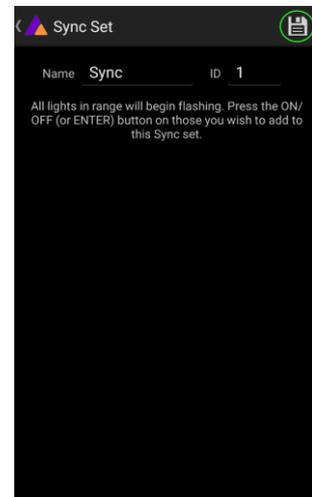

Now all lights will flicker every two seconds. Tap the Enter button of your light to add it to the set. Additionally, the name of the set can be customized. When finished, press the save button.

### 8.4.2 FLOW SET

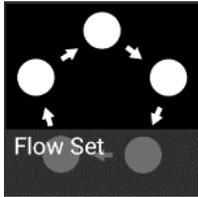

By using a Flow-Set, lights can also be controlled together. But additionally, they are assigned to positions inside the Flow-Set and so form a virtual light with several pixels. All effects, like a running light, are stretched over this virtual light.

#### CREAT A FLOW-SET:

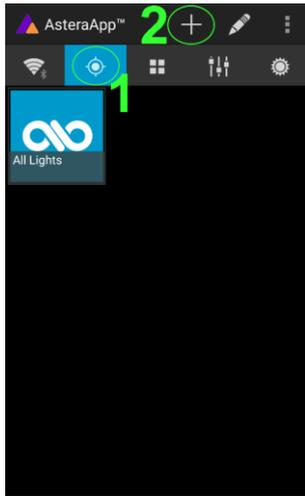

On the AsteraApp™ main screen, first press the Targets button (1) and then the "+" sign (2) to add a new target.

Then choose "Flow-Set".

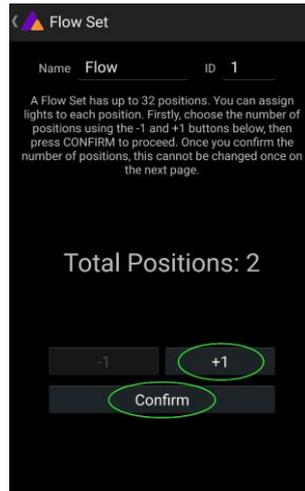

Each flow set can have up to 32 positions. Once the correct number is entered, press "Confirm".

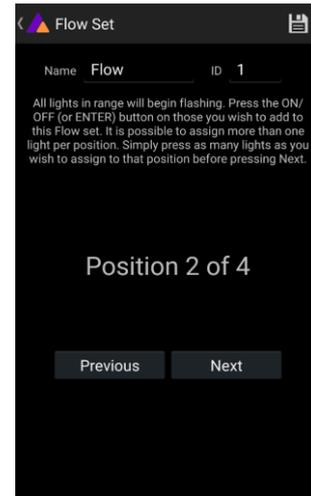

Now your lights will flicker every two seconds. To add a light to the currently shown position of this set, press its button. Walk through the positions by "Previous" and "Next" and assign your lights. When finished, press the save button on top.

## 8.5 TARGETING LIGHTS

Once you have created a set, you may now choose to control it. By default "All lights" are targeted. That includes all sets.

It is possible to target more than one set at a time.

#### NOTE:

*Even while targeting „All Lights" the Flow-Sets position arrangements persist. The lights still form a virtual big light of several positions.*

To modify, delete or arrange targets, use the pen button (1).

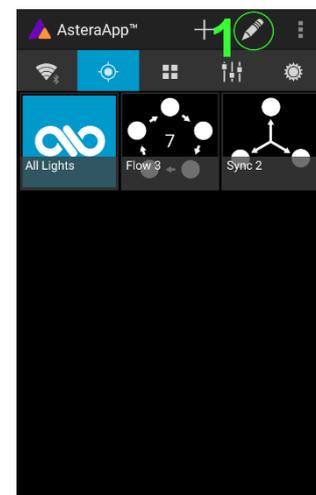

## 8.6 CHANGING THE EFFECT



On the AsteraApp™ main screen, press “Wedding” (1), then enter the editor (2).

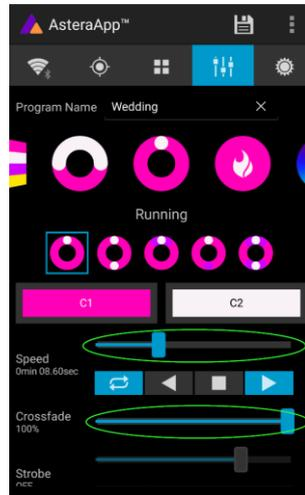

Set “Crossfade” to 0% and “Speed” to around 2 seconds. You should see a clean running light now. The White light will run over a pink background.

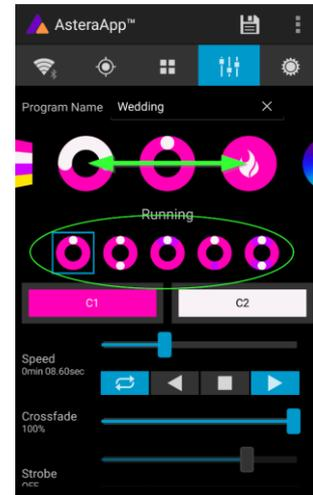

The effect can be changed by sliding the effect picker and choosing a sub-effect below it. Again the colors can be adjusted, too.

After the effect is adjusted, it may be saved back to the main screen by pressing the save button.

### AN EFFECT CAN BE HIGHLY CUSTOMIZED:



The speed tells how long it will take for the effect to complete one cycle.



The crossfade tells if the light will fade from step to step. If it is set to 0% an immediate change is visible. If set to 100% the changes will be soft.

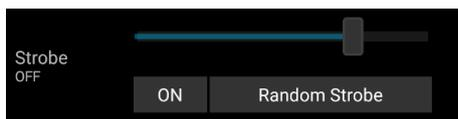

Stroboscope effect can be enabled and seamlessly adjusted in speed. Additionally, three random stroboscope options are available: slow, medium and fast.



Each effect can be adjusted in brightness as well.

## 8.7 LIST OF EFFECTS

The effects' patterns are pre-defined and cannot be modified by the user. They are pre-programmed inside of each light. Still they can be parameterized. These effects are:

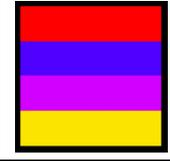
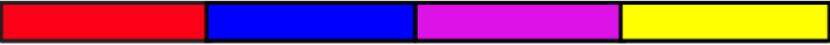
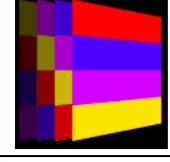
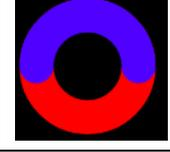
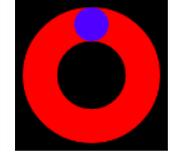
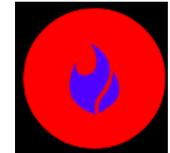
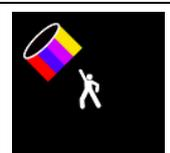
	<p>A static color is displayed. There are also options that show two, three or four static colors at a time. The Flow-Set is then divided into several parts of equal length:</p> 
	<p>Fading colors. The four defined colors are displayed one after the other. The setup fade is applied between them. Again, the Flow-Set can be split in up to four segments.</p>
	<p>From both sides of a Flow-Set, the color changes position by position from C1 to C2. Once the whole Set is C2, it changes back to C1 in the same way.</p>
	<p>The color of the Flow-Set changes position by position. After all positions show the same color, a new cycle is started.</p>
	<p>Several variations of running lights are available.</p>
	<p>The Fire effect shows a random flickering effect. The background color and the color of the flickering effect can be adjusted.</p>
	<p>The rainbow effect shows a color change through all colors. Only its speed can be adjusted.</p>
	<p>Chaser effects provide an efficient means to create dancefloor lighting. The static chaser exchanges the color of the lights according to the tapped-in beat. The colors are randomly chosen. The effect can be adjusted to show up to 4 different colors at a time.</p>
	<p>The Moving Chasers overlay the static chaser by a second movement of the four displayed colors over the available positions of a Flow-Set. This gets mostly interesting if the Moving Strobe is chosen. Then, only some of the positions strobe and they are moving. So the strobe effect moves over the Flow-Set.</p>
	<p>When using the Chaser With Background, additionally a color can be selected that is mostly used, the background color.</p>

## 8.8 CHASER EFFECTS IN DEPTH

To display chaser effects, it is recommended to setup a Flow-Set with a multiple of four positions. This is the way they will be shown best. Those four positions could then be arranged in the corners of a dance floor for example.

Use the tap-sync button to tap the beat of the music; the Chaser Effects will base their color changing on that beat then.

The Chaser Effects offer additional controls



The Emphasis adjusts the way the colors are exchanged by the chaser:

Emphasis	Effect
-2	The four colors of the palette are exchanged one by one. Every beat changes only one color.
-1	Same as "-2", but the color change is animated with the color-wheel effect; it mimics the color change of a traditional color wheel, showing intermediate colors during the change.
0	All four colors are exchanged on every beat.
1	Same as "0", but the color wheel effect is added.
2	Same as "0", but on the fourth beat, all colors go black. They come on again on the next beat.
3	Same as "0", but all colors go black on every second beat. This setting produces a strong on-off effect in sync with the beat.



The softness influences the fading between colors that happens on every beat. 0% will generate a hard change of the colors, while 100% makes them fade very slowly.



A random button is added to the color bar. If it is latched, random colors are chosen on every beat. If not (like in the above picture), then the colors are always chosen randomly from the color pallet of four. This is useful to intentionally narrow down the color choice. Nice effect can be generated by setting some of them to black.

## 8.9 THE MAIN SCREEN

Here each program is represented by a tile. Those tiles can be edited and freely positioned. Several pages of tiles are available.



To move or delete a tile, press the pen icon (2). A popup will show the available actions. To add a new program tile, press the "+" icon (1).

While adding a file, either a default "Static Red" or the currently running program can be selected. Additionally, special function tiles are available.

### 8.9.1 Function Tiles

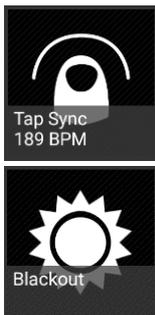

Tapping this tile several times to the beat will let the Chaser Effects change their colors to the beat. A chaser effect has a dancer symbol on the tile.



This button can be used to quickly blackout lights. The currently set target must be observed, as the blackout function will only affect the currently targeted lights.

## 8.10 BRIGHTNESS

Additionally to each programs brightness slider mentioned in chapter 8.6, a master brightness control is available.

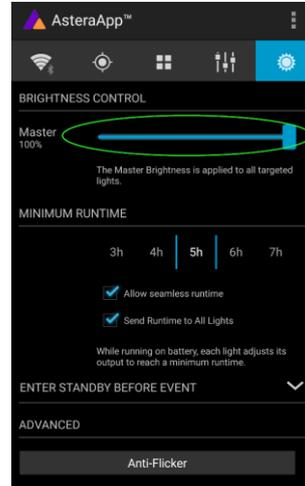
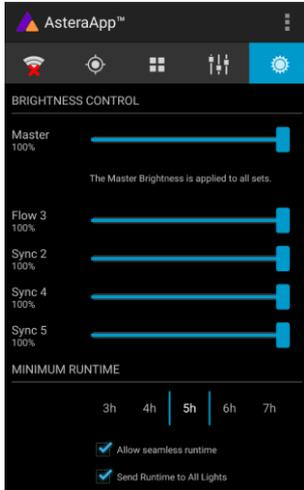

As soon as more than one Set is created and at least one set is currently targeted, a sub-master for each Set is shown.

Otherwise, only one slider is available. It controls the brightness of all currently targeted lights.

### 8.10.1 Set Sub-Masters

Each Set has its own brightness slider. Additionally, there is a master slider that controls the brightness of all Sets simultaneously. This is very similar to the group brightness control of common lighting desks.

**NOTE:**

The Set-Masters are only shown if:

- a) More than one Set has been created before
- b) Only Set-Targets are currently selected. Selecting any other type of target, like "All Lights" will hide the Set-Masters. This is necessary to avoid that one lights gets redundant brightness information; it would flicker constantly between different brightness levels.

## 8.11 RUNTIME

The light is able to adjust its power to meet a certain runtime on battery. The runtime is always calculated for a full battery.

### Example:

*If the light is required to light during an eight hour event, and one hour of setup time is scheduled, then the runtime should be set to nine hours immediately after the first power up.*

Please note, that the light should not be stored below 20°C before an event, otherwise the runtime might be shorter than calculated.

More details on the built-in battery can be found at chapter 4.2.

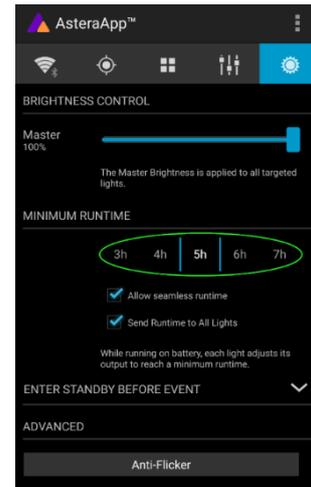

## 8.12 ANTI-FLICKER

The AsteraApp has an Anti-Flicker function where the PWM rate of spotlights (AX3/5/7/10) can be adjusted. For the Titan Tube this feature does not have any effect. The Titan Tube operates on a scrambled PWM rate which does not cause flicker effects when being filmed.

## 8.13 THEFT ALARM

Your light is equipped with a theft alarm. A motion sensor in the light detects when it is moved/taken away and a small siren will sound to deter potential thieves.

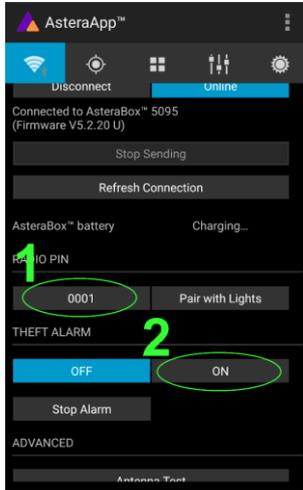

First make sure your Radio PIN is different from 0000. See chapter 8.1 how to change it. Then press the "ON" button.

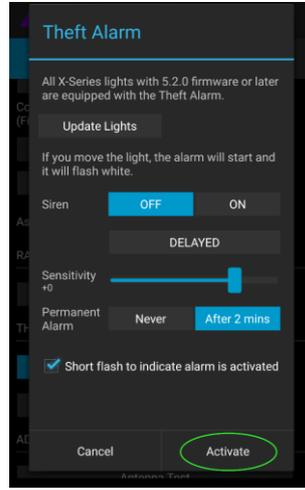

Press "Activate". All targeted lights will flash shortly to indicate that they are now armed.

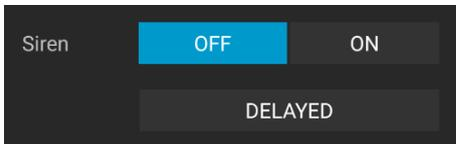

If the siren is set to DELAYED, it sounds only if the alarm persists for more than 6 seconds. The ON setting makes it sound immediately, while the OFF setting mutes it always.



The sensitivity can be adjusted to meet your environment. A lower value makes a false alarm more unlikely.

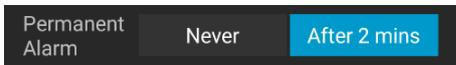

In case a potential thief is taking the light away while ignoring the alarm, he will most likely cause alarm events for more than 2 minutes in a row. In that case, the alarm can be set to become permanent. Then it won't stop, even if the light is placed down again. It will run until the battery is empty, rendering the light useless for the thief.

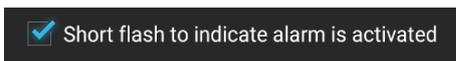

In some applications it is not desirable to have the lights flashing while the alarm is enabled or disabled. It can be disabled by this option easily.

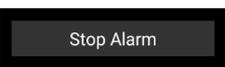

The alarm can be silenced without turning it off by pressing this button.

### NOTE:

To turn the alarm off again, an AsteraApp™ with the same Radio PIN must be used. Do not forget your Radio PIN! Otherwise, your light cannot be used normally anymore.

## 8.14 ENTER AND LEAVE STANDBY

The standby is intended to be used between setup and event (see chapter 4.2.1). After setup is completed, all lights may be switched to standby mode and woken up later when the event starts. This ensures that no battery runtime is wasted. This can be either done manually or automated.

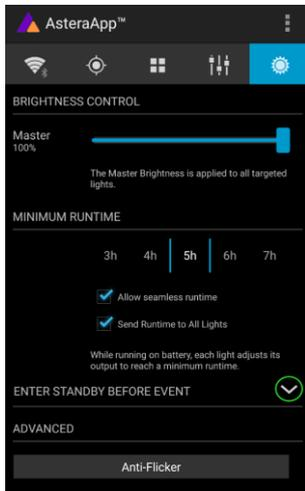

Press the small arrow to open the standby menu.

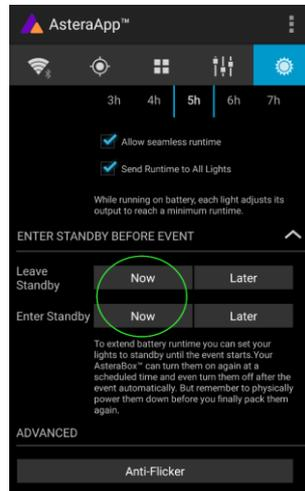

By pressing the “Now” buttons, standby can be switched on or off for all currently targeted lights.

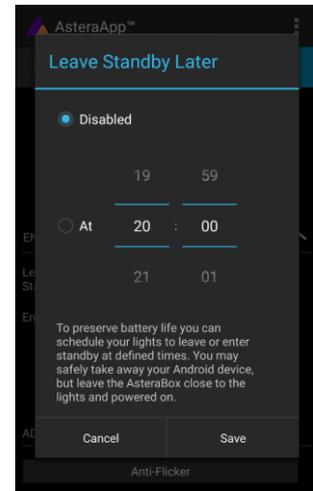

Any of the “Later” buttons will require a time to be set. The standby will be scheduled to the specified time.

**NOTE:**

*While you are using the “Now” function, only those lights that are currently targeted are addressed (see chapter 8.5 how to target lights). The “Later” function always sends to the “All Lights” target!*

## 8.15 DMX SETTINGS

In order to efficiently use the light with DMX, some setting can be adjusted by the AsteraApp™.

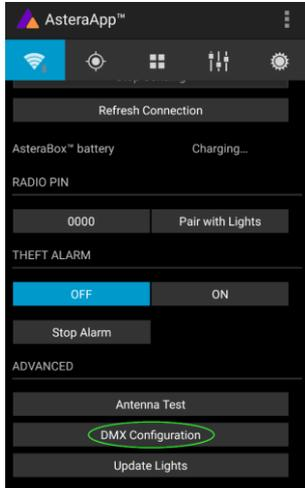

Press the “DMX Configuration” button.

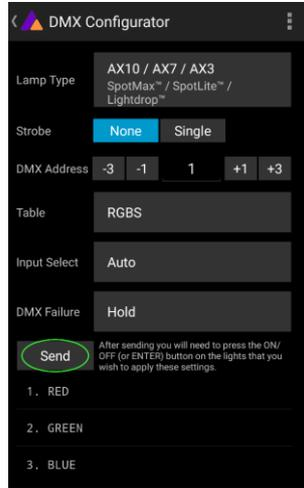

Adjust all settings to your requirements, then press “Send”.

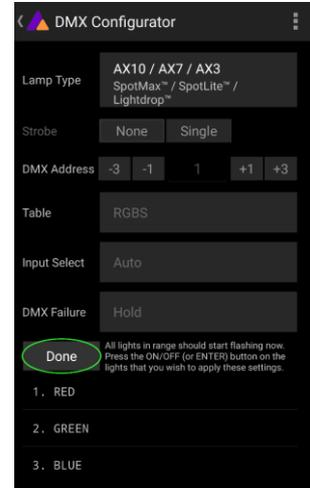

Your lights will start to flicker. Tap the lights you wish to setup (chapter 7.10). Then press “Done”.

Please refer to chapter 7.12, *Input Select*, and chapter 7.14, *DMX Settings*, for details on the available settings.

### 8.15.1 DMX Channel Assignment

The current channel assignment can be always reviewed in the lower part of the screen. It is automatically calculated based on the setting of Table and Strobe.

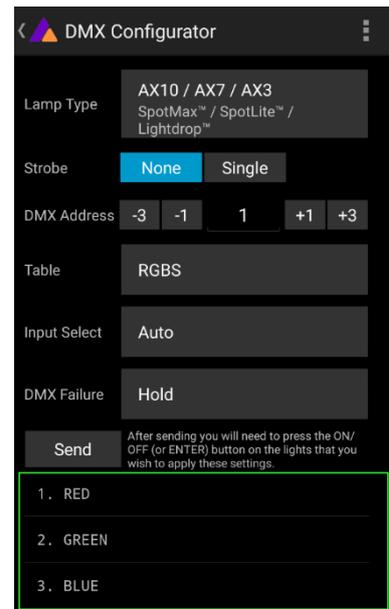

## 9 MENU OVERVIEW

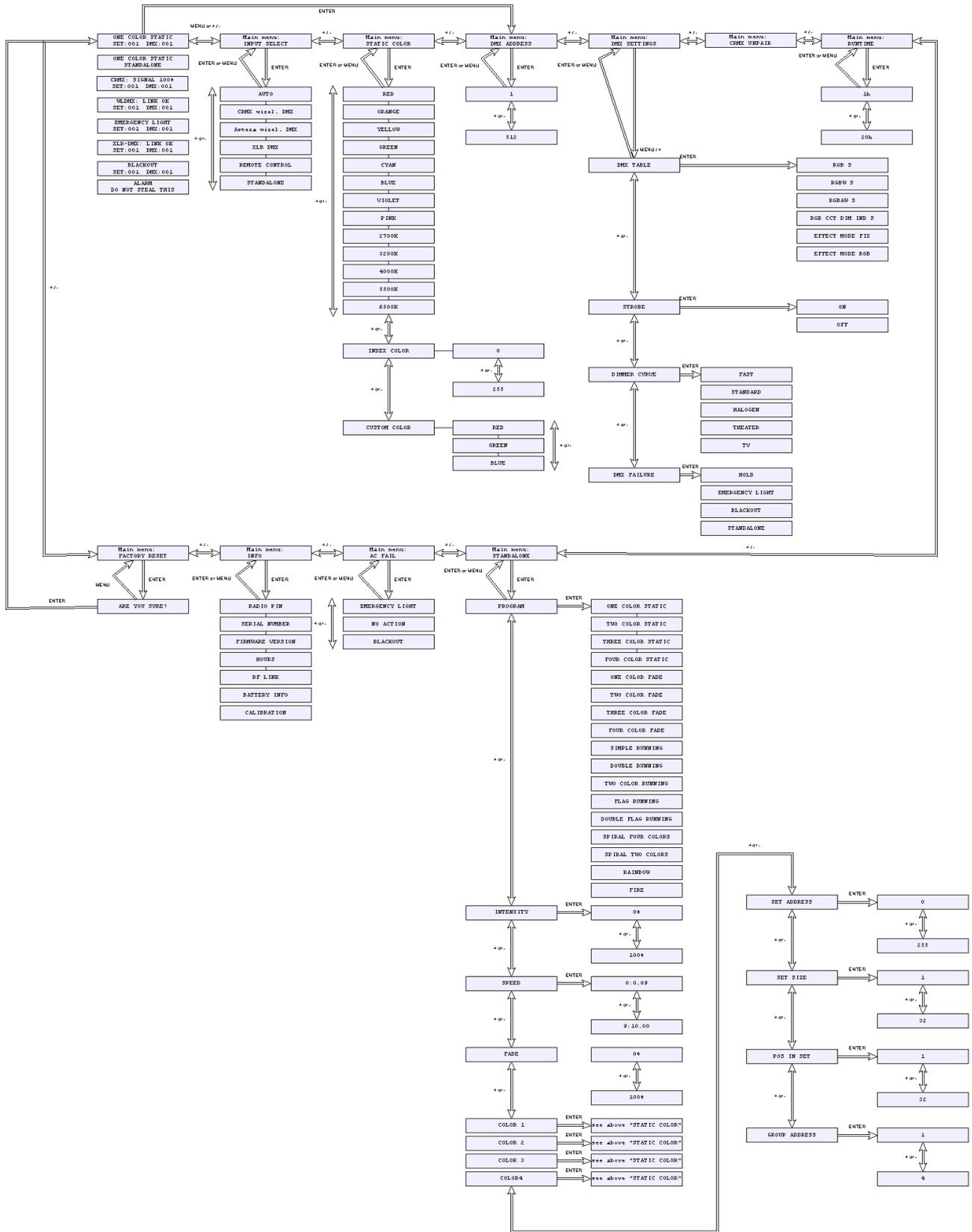



## 10 DMX PROFILE TABLES

---

### 1: RGB (PIXELS = 1; STROBE = OFF)

CHANNEL	VALUE	PERCENTAGE	FUNCTION
1	0 - 255	0 - 100	<b>Intensity Red</b> (0% --> 100%)
2	0 - 255	0 - 100	<b>Intensity Green</b> (0% --> 100%)
3	0 - 255	0 - 100	<b>Intensity Blue</b> (0% --> 100%)



## 2: RGBS (PIXELS = 1; STROBE = OFF)

CHANNEL	VALUE	PERCENTAGE	FUNCTION
1	0 - 255	0 - 100	<b>Intensity Red</b> (0% --> 100%)
2	0 - 255	0 - 100	<b>Intensity Green</b> (0% --> 100%)
3	0 - 255	0 - 100	<b>Intensity Blue</b> (0% --> 100%)
4	0 - 255	0 - 100	<b>Intensity Emulated White</b> (0% --> 100%)



### 3: RGBAW (PIXEL = 1; STROBE = OFF)

CHANNEL	VALUE	PERCENTAGE	FUNCTION
1	0 - 255	0 - 100	<b>Intensity Red</b> (0% --> 100%)
2	0 - 255	0 - 100	<b>Intensity Green</b> (0% --> 100%)
3	0 - 255	0 - 100	<b>Intensity Blue</b> (0% --> 100%)
4	0 - 255	0 - 100	<b>Intensity Amber</b> (0% --> 100%)
5	0 - 255	0 - 100	<b>Intensity Emulated White</b> (0% --> 100%)



#### 4: DIM RGB (PIXEL = 1; STROBE = OFF)

CHANNEL	VALUE	PERCENTAGE	FUNCTION
1	0 - 255	0 - 100	<b>Dimmer</b> (closed --> open)
2	0 - 255	0 - 100	<b>Intensity Red</b> (0% --> 100%)
3	0 - 255	0 - 100	<b>Intensity Green</b> (0% --> 100%)
4	0 - 255	0 - 100	<b>Intensity Blue</b> (0% --> 100%)



## 5: DIM RGBW (PIXEL = 1; STROBE = OFF)

CHANNEL	VALUE	PERCENTAGE	FUNCTION
1	0 - 255	0 - 100	<b>Dimmer</b> (closed --> open)
2	0 - 255	0 - 100	<b>Intensity Red</b> (0% --> 100%)
3	0 - 255	0 - 100	<b>Intensity Green</b> (0% --> 100%)
4	0 - 255	0 - 100	<b>Intensity Blue</b> (0% --> 100%)
5	0 - 255	0 - 100	<b>Intensity Emulated White</b> (0% --> 100%)



## 6: DIM RGBAW (PIXEL = 1; STROBE = OFF)

CHANNEL	VALUE	PERCENTAGE	FUNCTION
1	0 - 255	0 - 100	<b>Dimmer</b> (closed --> open)
2	0 - 255	0 - 100	<b>Intensity Red</b> (0% --> 100%)
3	0 - 255	0 - 100	<b>Intensity Green</b> (0% --> 100%)
4	0 - 255	0 - 100	<b>Intensity Blue</b> (0% --> 100%)
5	0 - 255	0 - 100	<b>Intensity Amber</b> (0% --> 100%)
6	0 - 255	0 - 100	<b>Intensity Emulated White</b> (0% --> 100%)

## 7: RGB CCT DIM IND (PIXEL = 1; STROBE = OFF)

CHANNEL	VALUE	PERCENTAGE	FUNCTION
1	0 - 255	0 - 100	<b>Intensity Red</b> (0% --> 100%)
2	0 - 255	0 - 100	<b>Intensity Green</b> (0% --> 100%)
3	0 - 255	0 - 100	<b>Intensity Blue</b> (0% --> 100%)
4	0 - 4 4 - 255	0 - 1.5 1.6-100	<b>Color Temperature (CCT)</b> No effect Display color temperature Formula: $CCT = 2000 + 20 * DMX-Value$ Example:           50 --> 3000K 100 --> 4000K 150 --> 5000K  <i>*CCT overwrites the RGB setting</i>
5	0..255	0 - 100	<b>Dimmer</b> (closed --> open)
6	0..1 2..255	0 - 0.4 0.8 - 100	<b>LEE Color Gel</b> No effect Display LEE color gel (full list on page 171) <i>*LEE Color Gel overwrites both, RGB and CCT</i>



### 8: RGBS (PIXEL = 1; STROBE = SINGLE)

CHANNEL	VALUE	PERCENTAGE	FUNCTION
1	0 - 255	0 - 100	<b>Intensity Red</b> (0% --> 100%)
2	0 - 255	0 - 100	<b>Intensity Green</b> (0% --> 100%)
3	0 - 255	0 - 100	<b>Intensity Blue</b> (0% --> 100%)
4	0 - 3 4 5 6 7 - 255	0 - 1.2 1.6 2.0 2.4 2.7 - 100	<b>Strobe</b> Off Random Fast Random Medium Random Slow Variable Strobe (0.4Hz --> 25Hz)



### 9: RGBWS (PIXEL = 1; STROBE = SINGLE)

CHANNEL	VALUE	PERCENTAGE	FUNCTION
1	0 - 255	0 - 100	<b>Intensity Red</b> (0% --> 100%)
2	0 - 255	0 - 100	<b>Intensity Green</b> (0% --> 100%)
3	0 - 255	0 - 100	<b>Intensity Blue</b> (0% --> 100%)
4	0 - 255	0 - 100	<b>Intensity Emulated White</b> (0% --> 100%)
5	0 - 3 4 5 6 7 - 255	0 - 1.2 1.6 2.0 2.4 2.7 - 100	<b>Strobe</b> Off Random Fast Random Medium Random Slow Variable Strobe (0.4Hz --> 25Hz)



## 10: RGBAWS (PIXEL = 1; STROBE = SINGLE)

CHANNEL	VALUE	PERCENTAGE	FUNCTION
1	0 - 255	0 - 100	<b>Intensity Red</b> (0% --> 100%)
2	0 - 255	0 - 100	<b>Intensity Green</b> (0% --> 100%)
3	0 - 255	0 - 100	<b>Intensity Blue</b> (0% --> 100%)
4	0 - 255	0 - 100	<b>Intensity Amber</b> (0% --> 100%)
5	0 - 255	0 - 100	<b>Intensity Emulated White</b> (0% --> 100%)
6	0 - 3 4 5 6 7 - 255	0 - 1.2 1.6 2.0 2.4 2.7 - 100	<b>Strobe</b> Off Random Fast Random Medium Random Slow Variable Strobe (0.4Hz --> 25Hz)



### 11: DIM RGBS (PIXEL = 1; STROBE = SINGLE)

CHANNEL	VALUE	PERCENTAGE	FUNCTION
1	0 - 255	0 - 100	<b>Dimmer</b> (closed --> open)
2	0 - 255	0 - 100	<b>Intensity Red</b> (0% --> 100%)
3	0 - 255	0 - 100	<b>Intensity Green</b> (0% --> 100%)
4	0 - 255	0 - 100	<b>Intensity Blue</b> (0% --> 100%)
5	0 - 3 4 5 6 7 - 255	0 - 1.2 1.6 2.0 2.4 2.7 - 100	<b>Strobe</b> Off Random Fast Random Medium Random Slow Variable Strobe (0.4Hz --> 25Hz)



## 12: DIM RGBWS (PIXEL = 1; STROBE = SINGLE)

CHANNEL	VALUE	PERCENTAGE	FUNCTION
1	0 - 255	0 - 100	<b>Dimmer</b> (closed --> open)
2	0 - 255	0 - 100	<b>Intensity Red</b> (0% --> 100%)
3	0 - 255	0 - 100	<b>Intensity Green</b> (0% --> 100%)
4	0 - 255	0 - 100	<b>Intensity Blue</b> (0% --> 100%)
5	0 - 255	0 - 100	<b>Intensity Emulated White</b> (0% --> 100%)
6	0 - 3 4 5 6 7 - 255	0 - 1.2 1.6 2.0 2.4 2.7 - 100	<b>Strobe</b> Off Random Fast Random Medium Random Slow Variable Strobe (0.4Hz --> 25Hz)



### 13: DIM RGBAWS (PIXEL = 1; STROBE = SINGLE)

CHANNEL	VALUE	PERCENTAGE	FUNCTION
1	0 - 255	0 - 100	<b>Dimmer</b> (closed --> open)
2	0 - 255	0 - 100	<b>Intensity Red</b> (0% --> 100%)
3	0 - 255	0 - 100	<b>Intensity Green</b> (0% --> 100%)
4	0 - 255	0 - 100	<b>Intensity Blue</b> (0% --> 100%)
5	0 - 255	0 - 100	<b>Intensity Amber</b> (0% --> 100%)
6	0 - 255	0 - 100	<b>Intensity Emulated White</b> (0% --> 100%)
7	0 - 3	0 - 1.2	<b>Strobe</b> Off
	4	1.6	Random Fast
	5	2.0	Random Medium
	6	2.4	Random Slow
	7 - 255	2.7 - 100	Variable Strobe (0.4Hz --> 25Hz)

## 14: RGB CCT DIM IND S (PIXEL = 1; STROBE = SINGLE)

CHANNEL	VALUE	PERCENTAGE	FUNCTION
1	0 - 255	0 - 100	<b>Intensity Red</b> (0% --> 100%)
2	0 - 255	0 - 100	<b>Intensity Green</b> (0% --> 100%)
3	0 - 255	0 - 100	<b>Intensity Blue</b> (0% --> 100%)
4	0 - 4 4 - 255	0 - 1.5 1.6 - 100	<b>Color Temperature (CCT)</b> No effect Display color temperature Formula: $CCT = 2000 + 20 * DMX\text{-Value}$ Example:           50 --> 3000K 100 --> 4000K 150 --> 5000K  <i>*CCT overwrites the RGB setting</i>
5	0..255	0 - 100	<b>Dimmer</b> (closed --> open)
6	0..1 2..255	0 - 0.4 0.8 - 100	<b>LEE Color Gel</b> No effect Display LEE color gel (full list on page 171) <i>*LEE Color Gel overwrites both, RGB and CCT</i>
7	0 - 3 4 5 6 7 - 255	0 - 1.2 1.6 2.0 2.4 2.7 - 100	<b>Strobe</b> Off Random Fast Random Medium Random Slow Variable Strobe (0.4Hz --> 25Hz)

## 15: EFFECT MODE FIX

CHANNEL	VALUE	PERCENTAGE	FUNCTION
1	0..255	0 - 100	<b>Dimmer of Pixel 1</b> (closed --> open)
2	0 - 3 4 5 6 7 - 255	0 - 1.2 1.6 2.0 2.4 2.7 - 100	<b>Strobe</b> Off Random Fast Random Medium Random Slow Variable Strobe (0.4Hz --> 25Hz)
3	0 - 7 8 - 15 16 - 23 24 - 31 32 - 39 40 - 47 48 - 55 56 - 63 64 - 71 72 - 79 80 - 87 88 - 95 96 - 101 102 - 109 110 - 117 118 - 125 126 - 133 134 - 141 142 - 149 150 - 171	0 - 2.7 3.1 - 5.9 6.3 - 9.0 9.4 - 12.2 12.5 - 15.3 15.7 - 18.4 18.8 - 21.6 22.0 - 24.7 25.1 - 27.8 28.2 - 31.0 31.4 - 34.1 34.5 - 37.3 37.6 - 39.6 40.0 - 42.7 43.1 - 45.9 46.3 - 49.0 49.4 - 52.2 52.5 - 55.3 55.7 - 58.4 58.8 - 61.6	<b>Program</b> One Color Static Two Color Static Three Color Static Four Color Static One Color Fade Two Color Fade Three Color Fade Four Color Fade Simple Running Double Running Two Col Running Flag Running Double Flag Running Spiral 4 Color Spiral 2 Color Rainbow Fire Rotor Rotor Split 2 Rotor Split 4
4	0..255	0 - 100	<b>Speed</b> (slow --> fast)
5	0..255	0 - 100	<b>Crossfade</b> (no fade --> smooth fade)
6	0 - 63 64 - 127 128 - 190 191 - 255	0 - 24.7 25.1 - 49.8 50.2 - 74.5 74.9 - 100	<b>Direction</b> Forward with Loop Forward one time and stop Reverse one time and stop Reverse with Loop
7	0 - 63 64 - 127 128 - 190 191 - 255	0 - 24.7 25.1 - 49.8 50.2 - 74.5 74.9 - 100	<b>Size</b> <i>Defines the virtual size of the program in groups</i> <i>E.g. if SIZE is set to 2 groups only half of the program is shown on the unit.</i> 1 Group 2 Groups 3 Groups 4 Groups
8	0..255	0 - 100	<b>Offset</b> <i>If SIZE is set to &gt;1 group, the units pixels can be shifted within the virtually larger program.</i>



			<i>Increasing the OFFSET parameter scrolls the position of the unit within the virtual large program.</i>
9	0..255	0 - 100	<b>Restart Program</b> <i>If value is changed, the program starts again from the beginning (useful if DIRECTION is not set to loop).</i>
10	0..1 2..255	0 - 0.4 0.8 - 100	<b>LEE Color Gel 1</b> No effect Display LEE color gel (full list on page 171)
11	0..1 2..255	0 - 0.4 0.8 - 100	<b>LEE Color Gel 2</b> No effect Display LEE color gel (full list on page 171)
12	0..1 2..255	0 - 0.4 0.8 - 100	<b>LEE Color Gel 3</b> No effect Display LEE color gel (full list on page 171)
13	0..1 2..255	0 - 0.4 0.8 - 100	<b>LEE Color Gel 4</b> No effect Display LEE color gel (full list on page 171)

## 16: EFFECT MODE RGB

CHANNEL	VALUE	PERCENTAGE	FUNCTION
1	0..255	0 - 100	<b>Dimmer of Pixel 1</b> (closed --> open)
2	0 - 3	0 - 1.2	<b>Strobe</b> Off
	4	1.6	Random Fast
	5	2.0	Random Medium
	6	2.4	Random Slow
	7 - 255	2.7 - 100	Variable Strobe (0.4Hz --> 25Hz)
3	0 - 7	0 - 2.7	<b>Program</b> One Color Static
	8 - 15	3.1 - 5.9	Two Color Static
	16 - 23	6.3 - 9.0	Three Color Static
	24 - 31	9.4 - 12.2	Four Color Static
	32 - 39	12.5 - 15.3	One Color Fade
	40 - 47	15.7 - 18.4	Two Color Fade
	48 - 55	18.8 - 21.6	Three Color Fade
	56 - 63	22.0 - 24.7	Four Color Fade
	64 - 71	25.1 - 27.8	Simple Running
	72 - 79	28.2 - 31.0	Double Running
	80 - 87	31.4 - 34.1	Two Col Running
	88 - 95	34.5 - 37.3	Flag Running
	96 - 101	37.6 - 39.6	Double Flag Running
	102 - 109	40.0 - 42.7	Spiral 4 Color
	110 - 117	43.1 - 45.9	Spiral 2 Color
	118 - 125	46.3 - 49.0	Rainbow
126 - 133	49.4 - 52.2	Fire	
134 - 141	52.5 - 55.3	Rotor	
142 - 149	55.7 - 58.4	Rotor Split 2	
150 - 171	58.8 - 61.6	Rotor Split 4	
4	0..255	0 - 100	<b>Speed</b> (slow --> fast)
5	0..255	0 - 100	<b>Crossfade</b> (no fade --> smooth fade)
6	0 - 63	0 - 24.7	<b>Direction</b> Forward with Loop
	64 - 127	25.1 - 49.8	Forward one time and stop
	128 - 190	50.2 - 74.5	Reverse one time and stop
	191 - 255	74.9 - 100	Reverse with Loop
7			<b>Size</b> <i>Defines the virtual size of the program in groups E.g. if SIZE is set to 2 groups only half of the program is shown on the unit.</i>
	0 - 63	0 - 24.7	1 Group
	64 - 127	25.1 - 49.8	2 Groups
	128 - 190	50.2 - 74.5	3 Groups

	191 - 255	74.9 - 100	4 Groups
8	0..255	0 - 100	<b>Offset</b> <i>If SIZE is set to &gt;1 group, the unit's pixels can be shifted within the virtually larger program.  Increasing the OFFSET parameter scrolls the position of the unit within the virtual large program.</i>
9	0..255	0 - 100	<b>Restart Program</b> <i>If value is changed, the program starts again from the beginning (useful if DIRECTION is not set to loop).</i>
10	0 - 255	0 - 100	<b>Intensity Red of Color 1 (0% --&gt; 100%)</b>
11	0 - 255	0 - 100	<b>Intensity Green of Color 1 (0% --&gt; 100%)</b>
12	0 - 255	0 - 100	<b>Intensity Blue of Color 1 (0% --&gt; 100%)</b>
13	0 - 255	0 - 100	<b>Intensity Red of Color 1 (0% --&gt; 100%)</b>
14	0 - 255	0 - 100	<b>Intensity Green of Color 1 (0% --&gt; 100%)</b>
15	0 - 255	0 - 100	<b>Intensity Blue of Color 1 (0% --&gt; 100%)</b>
16	0 - 255	0 - 100	<b>Intensity Red of Color 1 (0% --&gt; 100%)</b>
17	0 - 255	0 - 100	<b>Intensity Green of Color 1 (0% --&gt; 100%)</b>
18	0 - 255	0 - 100	<b>Intensity Blue of Color 1 (0% --&gt; 100%)</b>
19	0 - 255	0 - 100	<b>Intensity Red of Color 1 (0% --&gt; 100%)</b>
20	0 - 255	0 - 100	<b>Intensity Green of Color 1 (0% --&gt; 100%)</b>
21	0 - 255	0 - 100	<b>Intensity Blue of Color 1 (0% --&gt; 100%)</b>

**17: RGB.RGB. (PIXEL = 4; STROBE = OFF)**

CHANNEL	VALUE	PERCENTAGE	FUNCTION
1	0 - 255	0 - 100	Intensity Red of Pixel 1 (0% --> 100%)
2	0 - 255	0 - 100	Intensity Green of Pixel 1 (0% --> 100%)
3	0 - 255	0 - 100	Intensity Blue of Pixel 1 (0% --> 100%)
4			No Effect
5	0 - 255	0 - 100	Intensity Red of Pixel 2 (0% --> 100%)
6	0 - 255	0 - 100	Intensity Green of Pixel 2 (0% --> 100%)
7	0 - 255	0 - 100	Intensity Blue of Pixel 2 (0% --> 100%)
8			No Effect
9	0 - 255	0 - 100	Intensity Red of Pixel 3 (0% --> 100%)
10	0 - 255	0 - 100	Intensity Green of Pixel 3 (0% --> 100%)
11	0 - 255	0 - 100	Intensity Blue of Pixel 3 (0% --> 100%)
12			No Effect
13	0 - 255	0 - 100	Intensity Red of Pixel 4 (0% --> 100%)
14	0 - 255	0 - 100	Intensity Green of Pixel 4 (0% --> 100%)
15	0 - 255	0 - 100	Intensity Blue of Pixel 4 (0% --> 100%)



### 18: RGB RGB (PIXEL = 4; STROBE = OFF)

CHANNEL	VALUE	PERCENTAGE	FUNCTION
1	0 - 255	0 - 100	Intensity Red of Pixel 1 (0% --> 100%)
2	0 - 255	0 - 100	Intensity Green of Pixel 1 (0% --> 100%)
3	0 - 255	0 - 100	Intensity Blue of Pixel 1 (0% --> 100%)
4	0 - 255	0 - 100	Intensity Red of Pixel 2 (0% --> 100%)
5	0 - 255	0 - 100	Intensity Green of Pixel 2 (0% --> 100%)
6	0 - 255	0 - 100	Intensity Blue of Pixel 2 (0% --> 100%)
7	0 - 255	0 - 100	Intensity Red of Pixel 3 (0% --> 100%)
8	0 - 255	0 - 100	Intensity Green of Pixel 3 (0% --> 100%)
9	0 - 255	0 - 100	Intensity Blue of Pixel 3 (0% --> 100%)
10	0 - 255	0 - 100	Intensity Red of Pixel 4 (0% --> 100%)
11	0 - 255	0 - 100	Intensity Green of Pixel 4 (0% --> 100%)
12	0 - 255	0 - 100	Intensity Blue of Pixel 4 (0% --> 100%)

## 19: RGBW RGBW (PIXEL = 4; STROBE = OFF)

CHANNEL	VALUE	PERCENTAGE	FUNCTION
1	0 - 255	0 - 100	Intensity Red of Pixel 1 (0% --> 100%)
2	0 - 255	0 - 100	Intensity Green of Pixel 1 (0% --> 100%)
3	0 - 255	0 - 100	Intensity Blue of Pixel 1 (0% --> 100%)
4	0 - 255	0 - 100	Intensity Emulated White of Pixel 1 (0% --> 100%)
5	0 - 255	0 - 100	Intensity Red of Pixel 2 (0% --> 100%)
6	0 - 255	0 - 100	Intensity Green of Pixel 2 (0% --> 100%)
7	0 - 255	0 - 100	Intensity Blue of Pixel 2 (0% --> 100%)
8	0 - 255	0 - 100	Intensity Emulated White of Pixel 2 (0% --> 100%)
9	0 - 255	0 - 100	Intensity Red of Pixel 3 (0% --> 100%)
10	0 - 255	0 - 100	Intensity Green of Pixel 3 (0% --> 100%)
11	0 - 255	0 - 100	Intensity Blue of Pixel 3 (0% --> 100%)
12	0 - 255	0 - 100	Intensity Emulated White of Pixel 3 (0% --> 100%)
13	0 - 255	0 - 100	Intensity Red of Pixel 4 (0% --> 100%)
14	0 - 255	0 - 100	Intensity Green of Pixel 4 (0% --> 100%)
15	0 - 255	0 - 100	Intensity Blue of Pixel 4 (0% --> 100%)
16	0 - 255	0 - 100	Intensity Emulated White of Pixel 4 (0% --> 100%)



## 20: RGBAW RGBAW (PIXEL = 4; STROBE = OFF)

CHANNEL	VALUE	PERCENTAGE	FUNCTION
1	0 - 255	0 - 100	Intensity Red of Pixel 1 (0% --> 100%)
2	0 - 255	0 - 100	Intensity Green of Pixel 1 (0% --> 100%)
3	0 - 255	0 - 100	Intensity Blue of Pixel 1 (0% --> 100%)
4	0 - 255	0 - 100	Intensity Amber (0% --> 100%)
5	0 - 255	0 - 100	Intensity Emulated White of Pixel 1(0% --> 100%)
6	0 - 255	0 - 100	Intensity Red of Pixel 2 (0% --> 100%)
7	0 - 255	0 - 100	Intensity Green of Pixel 2 (0% --> 100%)
8	0 - 255	0 - 100	Intensity Blue of Pixel 2 (0% --> 100%)
9	0 - 255	0 - 100	Intensity Amber (0% --> 100%)
10	0 - 255	0 - 100	Intensity Emulated White of Pixel 2(0% --> 100%)
11	0 - 255	0 - 100	Intensity Red of Pixel 3 (0% --> 100%)
12	0 - 255	0 - 100	Intensity Green of Pixel 3 (0% --> 100%)
13	0 - 255	0 - 100	Intensity Blue of Pixel 3 (0% --> 100%)
14	0 - 255	0 - 100	Intensity Amber (0% --> 100%)
15	0 - 255	0 - 100	Intensity Emulated White of Pixel 3(0% --> 100%)
16	0 - 255	0 - 100	Intensity Red of Pixel 4 (0% --> 100%)
17	0 - 255	0 - 100	Intensity Green of Pixel 4 (0% --> 100%)
18	0 - 255	0 - 100	Intensity Blue of Pixel 4 (0% --> 100%)
19	0 - 255	0 - 100	Intensity Amber (0% --> 100%)
20	0 - 255	0 - 100	Intensity Emulated White of Pixel 4(0% --> 100%)

## 21: DIM RGB DIM RGB (PIXEL = 4; STROBE = OFF)

CHANNEL	VALUE	PERCENTAGE	FUNCTION
1	0 - 255	0 - 100	<b>Dimmer of Pixel 1</b> (closed --> open)
2	0 - 255	0 - 100	<b>Intensity Red of Pixel 1</b> (0% --> 100%)
3	0 - 255	0 - 100	<b>Intensity Green of Pixel 1</b> (0% --> 100%)
4	0 - 255	0 - 100	<b>Intensity Blue of Pixel 1</b> (0% --> 100%)
5	0 - 255	0 - 100	<b>Dimmer of Pixel 2</b> (closed --> open)
6	0 - 255	0 - 100	<b>Intensity Red of Pixel 2</b> (0% --> 100%)
7	0 - 255	0 - 100	<b>Intensity Green of Pixel 2</b> (0% --> 100%)
8	0 - 255	0 - 100	<b>Intensity Blue of Pixel 2</b> (0% --> 100%)
9	0 - 255	0 - 100	<b>Dimmer of Pixel 3</b> (closed --> open)
10	0 - 255	0 - 100	<b>Intensity Red of Pixel 3</b> (0% --> 100%)
11	0 - 255	0 - 100	<b>Intensity Green of Pixel 3</b> (0% --> 100%)
12	0 - 255	0 - 100	<b>Intensity Blue of Pixel 3</b> (0% --> 100%)
13	0 - 255	0 - 100	<b>Dimmer of Pixel 4</b> (closed --> open)
14	0 - 255	0 - 100	<b>Intensity Red of Pixel 4</b> (0% --> 100%)
15	0 - 255	0 - 100	<b>Intensity Green of Pixel 4</b> (0% --> 100%)
16	0 - 255	0 - 100	<b>Intensity Blue of Pixel 4</b> (0% --> 100%)

## 22: DIM RGBW DIM RGBW (PIXEL = 4; STROBE = OFF)

CHANNEL	VALUE	PERCENTAGE	FUNCTION
1	0 - 255	0 - 100	<b>Dimmer of Pixel 1</b> (closed --> open)
2	0 - 255	0 - 100	<b>Intensity Red of Pixel 1</b> (0% --> 100%)
3	0 - 255	0 - 100	<b>Intensity Green of Pixel 1</b> (0% --> 100%)
4	0 - 255	0 - 100	<b>Intensity Blue of Pixel 1</b> (0% --> 100%)
5	0 - 255	0 - 100	<b>Intensity Emulated White of Pixel 1</b> (0% --> 100%)
6	0 - 255	0 - 100	<b>Dimmer of Pixel 2</b> (closed --> open)
7	0 - 255	0 - 100	<b>Intensity Red of Pixel 2</b> (0% --> 100%)
8	0 - 255	0 - 100	<b>Intensity Green of Pixel 2</b> (0% --> 100%)
9	0 - 255	0 - 100	<b>Intensity Blue of Pixel 2</b> (0% --> 100%)
10	0 - 255	0 - 100	<b>Intensity Emulated White of Pixel 2</b> (0% --> 100%)
11	0 - 255	0 - 100	<b>Dimmer of Pixel 3</b> (closed --> open)
12	0 - 255	0 - 100	<b>Intensity Red of Pixel 3</b> (0% --> 100%)
13	0 - 255	0 - 100	<b>Intensity Green of Pixel 3</b> (0% --> 100%)
14	0 - 255	0 - 100	<b>Intensity Blue of Pixel 3</b> (0% --> 100%)
15	0 - 255	0 - 100	<b>Intensity Emulated White of Pixel 3</b> (0% --> 100%)
16	0 - 255	0 - 100	<b>Dimmer of Pixel 4</b> (closed --> open)
17	0 - 255	0 - 100	<b>Intensity Red of Pixel 4</b> (0% --> 100%)
18	0 - 255	0 - 100	<b>Intensity Green of Pixel 4</b> (0% --> 100%)
19	0 - 255	0 - 100	<b>Intensity Blue of Pixel 4</b> (0% --> 100%)
20	0 - 255	0 - 100	<b>Intensity Emulated White of Pixel 4</b> (0% --> 100%)

### 23: DIM RGBAW DIM RGBAW (PIXEL = 4; STROBE = OFF)

CHANNEL	VALUE	PERCENTAGE	FUNCTION
1	0 - 255	0 - 100	<b>Dimmer of Pixel 1</b> (closed --> open)
2	0 - 255	0 - 100	<b>Intensity Red of Pixel 1</b> (0% --> 100%)
3	0 - 255	0 - 100	<b>Intensity Green of Pixel 1</b> (0% --> 100%)
4	0 - 255	0 - 100	<b>Intensity Blue of Pixel 1</b> (0% --> 100%)
5	0 - 255	0 - 100	<b>Intensity Amber</b> (0% --> 100%)
6	0 - 255	0 - 100	<b>Intensity Emulated White of Pixel 1</b> (0% --> 100%)
7	0 - 255	0 - 100	<b>Dimmer of Pixel 2</b> (closed --> open)
8	0 - 255	0 - 100	<b>Intensity Red of Pixel 2</b> (0% --> 100%)
9	0 - 255	0 - 100	<b>Intensity Green of Pixel 2</b> (0% --> 100%)
10	0 - 255	0 - 100	<b>Intensity Blue of Pixel 2</b> (0% --> 100%)
11	0 - 255	0 - 100	<b>Intensity Amber</b> (0% --> 100%)
12	0 - 255	0 - 100	<b>Intensity Emulated White of Pixel 2</b> (0% --> 100%)
13	0 - 255	0 - 100	<b>Dimmer of Pixel 3</b> (closed --> open)
14	0 - 255	0 - 100	<b>Intensity Red of Pixel 3</b> (0% --> 100%)
15	0 - 255	0 - 100	<b>Intensity Green of Pixel 3</b> (0% --> 100%)
16	0 - 255	0 - 100	<b>Intensity Blue of Pixel 3</b> (0% --> 100%)
17	0 - 255	0 - 100	<b>Intensity Amber</b> (0% --> 100%)
18	0 - 255	0 - 100	<b>Intensity Emulated White of Pixel 3</b> (0% --> 100%)
19	0 - 255	0 - 100	<b>Dimmer of Pixel 4</b> (closed --> open)
20	0 - 255	0 - 100	<b>Intensity Red of Pixel 4</b> (0% --> 100%)
21	0 - 255	0 - 100	<b>Intensity Green of Pixel 4</b> (0% --> 100%)
22	0 - 255	0 - 100	<b>Intensity Blue of Pixel 4</b> (0% --> 100%)
23	0 - 255	0 - 100	<b>Intensity Amber</b> (0% --> 100%)
24	0 - 255	0 - 100	<b>Intensity Emulated White of Pixel 4</b> (0% --> 100%)

## 24: RGB CCT DIM IND (PIXEL = 4; STROBE = OFF)

CHANNEL	VALUE	PERCENTAGE	FUNCTION
1	0 - 255	0 - 100	<b>Intensity Red of Pixel 1</b> (0% --> 100%)
2	0 - 255	0 - 100	<b>Intensity Green of Pixel 1</b> (0% --> 100%)
3	0 - 255	0 - 100	<b>Intensity Blue of Pixel 1</b> (0% --> 100%)
4	0 - 4 4 - 255	0 - 1.5 1.6-100	<b>Color Temperature (CCT) of Pixel 1</b> No effect Display color temperature Formula: CCT = 2000 + 20*DMX-Value Example: 50 --> 3000K 100 --> 4000K 150 --> 5000K <i>*CCT overwrites the RGB setting</i>
5	0..255	0 - 100	<b>Dimmer of Pixel 1</b> (closed --> open)
6	0..1 2..255	0 - 0.4 0.8 - 100	<b>LEE Color Gel of Pixel 1</b> No effect Display LEE color gel (full list on page 171) <i>*LEE Color Gel overwrites both, RGB and CCT</i>
7	0 - 255	0 - 100	<b>Intensity Red of Pixel 2</b> (0% --> 100%)
8	0 - 255	0 - 100	<b>Intensity Green of Pixel 2</b> (0% --> 100%)
9	0 - 255	0 - 100	<b>Intensity Blue of Pixel 2</b> (0% --> 100%)
10	0 - 4 4 - 255	0 - 1.5 1.6-100	<b>Color Temperature (CCT) of Pixel 2</b> No effect Display color temperature Formula: CCT = 2000 + 20*DMX-Value Example: 50 --> 3000K 100 --> 4000K 150 --> 5000K <i>*CCT overwrites the RGB setting</i>
11	0..255	0 - 100	<b>Dimmer of Pixel 2</b> (closed --> open)
12	0..1 2..255	0 - 0.4 0.8 - 100	<b>LEE Color Gel of Pixel 2</b> No effect Display LEE color gel (full list on page 171) <i>*LEE Color Gel overwrites both, RGB and CCT</i>
13	0 - 255	0 - 100	<b>Intensity Red of Pixel 3</b> (0% --> 100%)
14	0 - 255	0 - 100	<b>Intensity Green of Pixel 3</b> (0% --> 100%)
15	0 - 255	0 - 100	<b>Intensity Blue of Pixel 3</b> (0% --> 100%)
16	0 - 4 4 - 255	0 - 1.5 1.6-100	<b>Color Temperature (CCT) of Pixel 3</b> No effect Display color temperature Formula: CCT = 2000 + 20*DMX-Value Example: 50 --> 3000K 100 --> 4000K 150 --> 5000K

			<i>*CCT overwrites the RGB setting</i>
17	0..255	0 - 100	<b>Dimmer of Pixel 3</b> (closed --> open)
18	0..1 2..255	0 - 0.4 0.8 - 100	<b>LEE Color Gel of Pixel 3</b> No effect Display LEE color gel (full list on page 171) <i>*LEE Color Gel overwrites both, RGB and CCT</i>
19	0 - 255	0 - 100	<b>Intensity Red of Pixel 4</b> (0% --> 100%)
20	0 - 255	0 - 100	<b>Intensity Green of Pixel 4</b> (0% --> 100%)
21	0 - 255	0 - 100	<b>Intensity Blue of Pixel 4</b> (0% --> 100%)
22	0 - 4 4 - 255	0 - 1.5 1.6-100	<b>Color Temperature (CCT) of Pixel 4</b> No effect Display color temperature Formula: $CCT = 2000 + 20 * DMX-Value$ Example:           50 --> 3000K 100 --> 4000K 150 --> 5000K <i>*CCT overwrites the RGB setting</i>
23	0..255	0 - 100	<b>Dimmer of Pixel 4</b> (closed --> open)
24	0..1 2..255	0 - 0.4 0.8 - 100	<b>LEE Color Gel of Pixel 4</b> No effect Display LEE color gel (full list on page 171) <i>*LEE Color Gel overwrites both, RGB and CCT</i>

## 25: RGB.RGBS (PIXEL = 4; STROBE = SINGLE)

CHANNEL	VALUE	PERCENTAGE	FUNCTION
1	0 - 255	0 - 100	Intensity Red of Pixel 1 (0% --> 100%)
2	0 - 255	0 - 100	Intensity Green of Pixel 1 (0% --> 100%)
3	0 - 255	0 - 100	Intensity Blue of Pixel 1 (0% --> 100%)
4	0 - 3 4 5 6 7 - 255	0 - 1.2 1.6 2.0 2.4 2.7 - 100	<b>Strobe for all Pixels</b> Off Random Fast Random Medium Random Slow Variable Strobe (0.4Hz --> 25Hz)
5	0 - 255	0 - 100	Intensity Red of Pixel 2 (0% --> 100%)
6	0 - 255	0 - 100	Intensity Green of Pixel 2 (0% --> 100%)
7	0 - 255	0 - 100	Intensity Blue of Pixel 2 (0% --> 100%)
8			No Effect
9	0 - 255	0 - 100	Intensity Red of Pixel 3 (0% --> 100%)
10	0 - 255	0 - 100	Intensity Green of Pixel 3 (0% --> 100%)
11	0 - 255	0 - 100	Intensity Blue of Pixel 3 (0% --> 100%)
12			No Effect
13	0 - 255	0 - 100	Intensity Red of Pixel 4 (0% --> 100%)
14	0 - 255	0 - 100	Intensity Green of Pixel 4 (0% --> 100%)
15	0 - 255	0 - 100	Intensity Blue of Pixel 4 (0% --> 100%)

## 26: RGB RGB .. S (PIXEL = 4; STROBE = SINGLE)

CHANNEL	VALUE	PERCENTAGE	FUNCTION
1	0 - 255	0 - 100	Intensity Red of Pixel 1 (0% --> 100%)
2	0 - 255	0 - 100	Intensity Green of Pixel 1 (0% --> 100%)
3	0 - 255	0 - 100	Intensity Blue of Pixel 1 (0% --> 100%)
4	0 - 255	0 - 100	Intensity Red of Pixel 2 (0% --> 100%)
5	0 - 255	0 - 100	Intensity Green of Pixel 2 (0% --> 100%)
6	0 - 255	0 - 100	Intensity Blue of Pixel 2 (0% --> 100%)
7	0 - 255	0 - 100	Intensity Red of Pixel 3 (0% --> 100%)
8	0 - 255	0 - 100	Intensity Green of Pixel 3 (0% --> 100%)
9	0 - 255	0 - 100	Intensity Blue of Pixel 3 (0% --> 100%)
10	0 - 255	0 - 100	Intensity Red of Pixel 4 (0% --> 100%)
11	0 - 255	0 - 100	Intensity Green of Pixel 4 (0% --> 100%)
12	0 - 255	0 - 100	Intensity Blue of Pixel 4 (0% --> 100%)
13	0 - 3 4 5 6 7 - 255	0 - 1.2 1.6 2.0 2.4 2.7 - 100	<b>Strobe for all Pixels</b> Off Random Fast Random Medium Random Slow Variable Strobe (0.4Hz --> 25Hz)



## 27: RGBW RGBW .. S (PIXEL = 4; STROBE = SINGLE)

CHANNEL	VALUE	PERCENTAGE	FUNCTION
1	0 - 255	0 - 100	Intensity Red of Pixel 1 (0% --> 100%)
2	0 - 255	0 - 100	Intensity Green of Pixel 1 (0% --> 100%)
3	0 - 255	0 - 100	Intensity Blue of Pixel 1 (0% --> 100%)
4	0 - 255	0 - 100	Intensity Emulated White of Pixel 1 (0% --> 100%)
5	0 - 255	0 - 100	Intensity Red of Pixel 2 (0% --> 100%)
6	0 - 255	0 - 100	Intensity Green of Pixel 2 (0% --> 100%)
7	0 - 255	0 - 100	Intensity Blue of Pixel 2 (0% --> 100%)
8	0 - 255	0 - 100	Intensity Emulated White of Pixel 2 (0% --> 100%)
9	0 - 255	0 - 100	Intensity Red of Pixel 3 (0% --> 100%)
10	0 - 255	0 - 100	Intensity Green of Pixel 3 (0% --> 100%)
11	0 - 255	0 - 100	Intensity Blue of Pixel 3 (0% --> 100%)
12	0 - 255	0 - 100	Intensity Emulated White of Pixel 3 (0% --> 100%)
13	0 - 255	0 - 100	Intensity Red of Pixel 4 (0% --> 100%)
14	0 - 255	0 - 100	Intensity Green of Pixel 4 (0% --> 100%)
15	0 - 255	0 - 100	Intensity Blue of Pixel 4 (0% --> 100%)
16	0 - 255	0 - 100	Intensity Emulated White of Pixel 4 (0% --> 100%)
17	0 - 3 4 5 6 7 - 255	0 - 1.2 1.6 2.0 2.4 2.7 - 100	<b>Strobe for all Pixels</b> Off Random Fast Random Medium Random Slow Variable Strobe (0.4Hz --> 25Hz)

## 28: RGBAW RGBAW .. S (PIXEL = 4; STROBE = SINGLE)

CHANNEL	VALUE	PERCENTAGE	FUNCTION
1	0 - 255	0 - 100	Intensity Red of Pixel 1 (0% --> 100%)
2	0 - 255	0 - 100	Intensity Green of Pixel 1 (0% --> 100%)
3	0 - 255	0 - 100	Intensity Blue of Pixel 1 (0% --> 100%)
4	0 - 255	0 - 100	Intensity Amber of Pixel 1 (0% --> 100%)
5	0 - 255	0 - 100	Intensity Emulated White of Pixel 1 (0% --> 100%)
6	0 - 255	0 - 100	Intensity Red of Pixel 2 (0% --> 100%)
7	0 - 255	0 - 100	Intensity Green of Pixel 2 (0% --> 100%)
8	0 - 255	0 - 100	Intensity Blue of Pixel 2 (0% --> 100%)
9	0 - 255	0 - 100	Intensity Amber of Pixel 2 (0% --> 100%)
10	0 - 255	0 - 100	Intensity Emulated White of Pixel 2 (0% --> 100%)
11	0 - 255	0 - 100	Intensity Red of Pixel 3 (0% --> 100%)
12	0 - 255	0 - 100	Intensity Green of Pixel 3 (0% --> 100%)
13	0 - 255	0 - 100	Intensity Blue of Pixel 3 (0% --> 100%)
14	0 - 255	0 - 100	Intensity Amber of Pixel 3 (0% --> 100%)
15	0 - 255	0 - 100	Intensity Emulated White of Pixel 3 (0% --> 100%)
16	0 - 255	0 - 100	Intensity Red of Pixel 4 (0% --> 100%)
17	0 - 255	0 - 100	Intensity Green of Pixel 4 (0% --> 100%)
18	0 - 255	0 - 100	Intensity Blue of Pixel 4 (0% --> 100%)
19	0 - 255	0 - 100	Intensity Amber of Pixel 4 (0% --> 100%)
20	0 - 255	0 - 100	Intensity Emulated White of Pixel 4 (0% --> 100%)
21	0 - 3 4 5 6 7 - 255	0 - 1.2 1.6 2.0 2.4 2.7 - 100	Strobe for all Pixels Off Random Fast Random Medium Random Slow Variable Strobe (0.4Hz --> 25Hz)



## 29: DIM RGB DIM RGB .. S (PIXEL = 4; STROBE = SINGLE)

CHANNEL	VALUE	PERCENTAGE	FUNCTION
1	0 - 255	0 - 100	<b>Dimmer of Pixel 1</b> (closed --> open)
2	0 - 255	0 - 100	<b>Intensity Red of Pixel 1</b> (0% --> 100%)
3	0 - 255	0 - 100	<b>Intensity Green of Pixel 1</b> (0% --> 100%)
4	0 - 255	0 - 100	<b>Intensity Blue of Pixel 1</b> (0% --> 100%)
5	0 - 255	0 - 100	<b>Dimmer of Pixel 2</b> (closed --> open)
6	0 - 255	0 - 100	<b>Intensity Red of Pixel 2</b> (0% --> 100%)
7	0 - 255	0 - 100	<b>Intensity Green of Pixel 2</b> (0% --> 100%)
8	0 - 255	0 - 100	<b>Intensity Blue of Pixel 2</b> (0% --> 100%)
9	0 - 255	0 - 100	<b>Dimmer of Pixel 3</b> (closed --> open)
10	0 - 255	0 - 100	<b>Intensity Red of Pixel 3</b> (0% --> 100%)
11	0 - 255	0 - 100	<b>Intensity Green of Pixel 3</b> (0% --> 100%)
12	0 - 255	0 - 100	<b>Intensity Blue of Pixel 3</b> (0% --> 100%)
13	0 - 255	0 - 100	<b>Dimmer of Pixel 4</b> (closed --> open)
14	0 - 255	0 - 100	<b>Intensity Red of Pixel 4</b> (0% --> 100%)
15	0 - 255	0 - 100	<b>Intensity Green of Pixel 4</b> (0% --> 100%)
16	0 - 255	0 - 100	<b>Intensity Blue of Pixel 4</b> (0% --> 100%)
17	0 - 3 4 5 6 7 - 255	0 - 1.2 1.6 2.0 2.4 2.7 - 100	<b>Strobe for all Pixels</b> Off Random Fast Random Medium Random Slow Variable Strobe (0.4Hz --> 25Hz)



### 30: DIM RGBW DIM RGBW .. S (PIXEL = 4; STROBE = SINGLE)

CHANNEL	VALUE	PERCENTAGE	FUNCTION
1	0 - 255	0 - 100	<b>Dimmer of Pixel 1</b> (closed --> open)
2	0 - 255	0 - 100	<b>Intensity Red of Pixel 1</b> (0% --> 100%)
3	0 - 255	0 - 100	<b>Intensity Green of Pixel 1</b> (0% --> 100%)
4	0 - 255	0 - 100	<b>Intensity Blue of Pixel 1</b> (0% --> 100%)
5	0 - 255	0 - 100	<b>Intensity Emulated White of Pixel 1</b> (0% --> 100%)
6	0 - 255	0 - 100	<b>Dimmer of Pixel 2</b> (closed --> open)
7	0 - 255	0 - 100	<b>Intensity Red of Pixel 2</b> (0% --> 100%)
8	0 - 255	0 - 100	<b>Intensity Green of Pixel 2</b> (0% --> 100%)
9	0 - 255	0 - 100	<b>Intensity Blue of Pixel 2</b> (0% --> 100%)
10	0 - 255	0 - 100	<b>Intensity Emulated White of Pixel 2</b> (0% --> 100%)
11	0 - 255	0 - 100	<b>Dimmer of Pixel 3</b> (closed --> open)
12	0 - 255	0 - 100	<b>Intensity Red of Pixel 3</b> (0% --> 100%)
13	0 - 255	0 - 100	<b>Intensity Green of Pixel 3</b> (0% --> 100%)
14	0 - 255	0 - 100	<b>Intensity Blue of Pixel 3</b> (0% --> 100%)
15	0 - 255	0 - 100	<b>Intensity Emulated White of Pixel 3</b> (0% --> 100%)
16	0 - 255	0 - 100	<b>Dimmer of Pixel 4</b> (closed --> open)
17	0 - 255	0 - 100	<b>Intensity Red of Pixel 4</b> (0% --> 100%)
18	0 - 255	0 - 100	<b>Intensity Green of Pixel 4</b> (0% --> 100%)
19	0 - 255	0 - 100	<b>Intensity Blue of Pixel 4</b> (0% --> 100%)
20	0 - 255	0 - 100	<b>Intensity Emulated White of Pixel 4</b> (0% --> 100%)
21	0 - 3 4 5 6 7 - 255	0 - 1.2 1.6 2.0 2.4 2.7 - 100	<b>Strobe for all Pixels</b> Off Random Fast Random Medium Random Slow Variable Strobe (0.4Hz --> 25Hz)

### 31: DIM RGBAW DIM RGBAW .. S (PIXEL = 4; STROBE = SINGLE)

CHANNEL	VALUE	PERCENTAGE	FUNCTION
1	0 - 255	0 - 100	<b>Dimmer of Pixel 1</b> (closed --> open)
2	0 - 255	0 - 100	<b>Intensity Red of Pixel 1</b> (0% --> 100%)
3	0 - 255	0 - 100	<b>Intensity Green of Pixel 1</b> (0% --> 100%)
4	0 - 255	0 - 100	<b>Intensity Blue of Pixel 1</b> (0% --> 100%)
5	0 - 255	0 - 100	<b>Intensity Amber of Pixel 1</b> (0% --> 100%)
6	0 - 255	0 - 100	<b>Intensity Emulated White of Pixel 1</b> (0% --> 100%)
7	0 - 255	0 - 100	<b>Dimmer of Pixel 2</b> (closed --> open)
8	0 - 255	0 - 100	<b>Intensity Red of Pixel 2</b> (0% --> 100%)
9	0 - 255	0 - 100	<b>Intensity Green of Pixel 2</b> (0% --> 100%)
10	0 - 255	0 - 100	<b>Intensity Blue of Pixel 2</b> (0% --> 100%)
11	0 - 255	0 - 100	<b>Intensity Amber of Pixel 2</b> (0% --> 100%)
12	0 - 255	0 - 100	<b>Intensity Emulated White of Pixel 2</b> (0% --> 100%)
13	0 - 255	0 - 100	<b>Dimmer of Pixel 3</b> (closed --> open)
14	0 - 255	0 - 100	<b>Intensity Red of Pixel 3</b> (0% --> 100%)
15	0 - 255	0 - 100	<b>Intensity Green of Pixel 3</b> (0% --> 100%)
16	0 - 255	0 - 100	<b>Intensity Blue of Pixel 3</b> (0% --> 100%)
17	0 - 255	0 - 100	<b>Intensity Amber of Pixel 3</b> (0% --> 100%)
18	0 - 255	0 - 100	<b>Intensity Emulated White of Pixel 3</b> (0% --> 100%)
19	0 - 255	0 - 100	<b>Dimmer of Pixel 4</b> (closed --> open)
20	0 - 255	0 - 100	<b>Intensity Red of Pixel 4</b> (0% --> 100%)
21	0 - 255	0 - 100	<b>Intensity Green of Pixel 4</b> (0% --> 100%)
22	0 - 255	0 - 100	<b>Intensity Blue of Pixel 4</b> (0% --> 100%)
23	0 - 255	0 - 100	<b>Intensity Amber of Pixel 4</b> (0% --> 100%)
24	0 - 255	0 - 100	<b>Intensity Emulated White of Pixel 4</b> (0% --> 100%)
25			<b>Strobe for all Pixels</b>
	0 - 3	0 - 1.2	Off
	4	1.6	Random Fast
	5	2.0	Random Medium
	6	2.4	Random Slow
	7 - 255	2.7 - 100	Variable Strobe (0.4Hz --> 25Hz)

### 32: RGB CCT DIM IND S (PIXEL = 4; STROBE = SINGLE)

CHANNEL	VALUE	PERCENTAGE	FUNCTION
1	0 - 255	0 - 100	<b>Intensity Red of Pixel 1</b> (0% --> 100%)
2	0 - 255	0 - 100	<b>Intensity Green of Pixel 1</b> (0% --> 100%)
3	0 - 255	0 - 100	<b>Intensity Blue of Pixel 1</b> (0% --> 100%)
4	0 - 4 4 - 255	0 - 1.5 1.6-100	<b>Color Temperature (CCT) of Pixel 1</b> No effect Display color temperature Formula: CCT = 2000 + 20*DMX-Value Example: 50 --> 3000K 100 --> 4000K 150 --> 5000K <i>*CCT overwrites the RGB setting</i>
5	0..255	0 - 100	<b>Dimmer of Pixel 1</b> (closed --> open)
6	0..1 2..255	0 - 0.4 0.8 - 100	<b>LEE Color Gel of Pixel 1</b> No effect Display LEE color gel (full list on page 171) <i>*LEE Color Gel overwrites both, RGB and CCT</i>
7	0 - 255	0 - 100	<b>Intensity Red of Pixel 2</b> (0% --> 100%)
8	0 - 255	0 - 100	<b>Intensity Green of Pixel 2</b> (0% --> 100%)
9	0 - 255	0 - 100	<b>Intensity Blue of Pixel 2</b> (0% --> 100%)
10	0 - 4 4 - 255	0 - 1.5 1.6-100	<b>Color Temperature (CCT) of Pixel 2</b> No effect Display color temperature Formula: CCT = 2000 + 20*DMX-Value Example: 50 --> 3000K 100 --> 4000K 150 --> 5000K <i>*CCT overwrites the RGB setting</i>
11	0..255	0 - 100	<b>Dimmer of Pixel 2</b> (closed --> open)
12	0..1 2..255	0 - 0.4 0.8 - 100	<b>LEE Color Gel of Pixel 2</b> No effect Display LEE color gel (full list on page 171) <i>*LEE Color Gel overwrites both, RGB and CCT</i>
13	0 - 255	0 - 100	<b>Intensity Red of Pixel 3</b> (0% --> 100%)
14	0 - 255	0 - 100	<b>Intensity Green of Pixel 3</b> (0% --> 100%)
15	0 - 255	0 - 100	<b>Intensity Blue of Pixel 3</b> (0% --> 100%)
16	0 - 4 4 - 255	0 - 1.5 1.6-100	<b>Color Temperature (CCT) of Pixel 3</b> No effect Display color temperature Formula: CCT = 2000 + 20*DMX-Value Example: 50 --> 3000K 100 --> 4000K 150 --> 5000K

			<i>*CCT overwrites the RGB setting</i>
17	0..255	0 - 100	<b>Dimmer of Pixel 3</b> (closed --> open)
18	0..1 2..255	0 - 0.4 0.8 - 100	<b>LEE Color Gel of Pixel 3</b> No effect Display LEE color gel (full list on page 171) <i>*LEE Color Gel overwrites both, RGB and CCT</i>
19	0 - 255	0 - 100	<b>Intensity Red of Pixel 4</b> (0% --> 100%)
20	0 - 255	0 - 100	<b>Intensity Green of Pixel 4</b> (0% --> 100%)
21	0 - 255	0 - 100	<b>Intensity Blue of Pixel 4</b> (0% --> 100%)
22	0 - 4 4 - 255	0 - 1.5 1.6-100	<b>Color Temperature (CCT) of Pixel 4</b> No effect Display color temperature Formula: $CCT = 2000 + 20 * DMX-Value$ Example:           50 --> 3000K 100 --> 4000K 150 --> 5000K <i>*CCT overwrites the RGB setting</i>
23	0..255	0 - 100	<b>Dimmer of Pixel 4</b> (closed --> open)
24	0..1 2..255	0 - 0.4 0.8 - 100	<b>LEE Color Gel of Pixel 4</b> No effect Display LEE color gel (full list on page 171) <i>*LEE Color Gel overwrites both, RGB and CCT</i>
25	0 - 3 4 5 6 7 - 255	0 - 1.2 1.6 2.0 2.4 2.7 - 100	<b>Strobe for all Pixels</b> Off Random Fast Random Medium Random Slow Variable Strobe (0.4Hz --> 25Hz)

### 33: RGBS RGBS (PIXEL = 4; STROBE = MULTIPLE)

CHANNEL	VALUE	PERCENTAGE	FUNCTION
1	0 - 255	0 - 100	<b>Intensity Red of Pixel 1</b> (0% --> 100%)
2	0 - 255	0 - 100	<b>Intensity Green of Pixel 1</b> (0% --> 100%)
3	0 - 255	0 - 100	<b>Intensity Blue of Pixel 1</b> (0% --> 100%)
4	0 - 3	0 - 1.2	<b>Strobe of Pixel 1</b> Off
	4	1.6	Random Fast
	5	2.0	Random Medium
	6	2.4	Random Slow
	7 - 255	2.7 - 100	Variable Strobe (0.4Hz --> 25Hz)
5	0 - 255	0 - 100	<b>Intensity Red of Pixel 2</b> (0% --> 100%)
6	0 - 255	0 - 100	<b>Intensity Green of Pixel 2</b> (0% --> 100%)
7	0 - 255	0 - 100	<b>Intensity Blue of Pixel 2</b> (0% --> 100%)
8	0 - 3	0 - 1.2	<b>Strobe of Pixel 2</b> Off
	4	1.6	Random Fast
	5	2.0	Random Medium
	6	2.4	Random Slow
	7 - 255	2.7 - 100	Variable Strobe (0.4Hz --> 25Hz)
9	0 - 255	0 - 100	<b>Intensity Red of Pixel 3</b> (0% --> 100%)
10	0 - 255	0 - 100	<b>Intensity Green of Pixel 3</b> (0% --> 100%)
11	0 - 255	0 - 100	<b>Intensity Blue of Pixel 3</b> (0% --> 100%)
12	0 - 3	0 - 1.2	<b>Strobe of Pixel 3</b> Off
	4	1.6	Random Fast
	5	2.0	Random Medium
	6	2.4	Random Slow
	7 - 255	2.7 - 100	Variable Strobe (0.4Hz --> 25Hz)
13	0 - 255	0 - 100	<b>Intensity Red of Pixel 4</b> (0% --> 100%)
14	0 - 255	0 - 100	<b>Intensity Green of Pixel 4</b> (0% --> 100%)
15	0 - 255	0 - 100	<b>Intensity Blue of Pixel 4</b> (0% --> 100%)
16	0 - 3	0 - 1.2	<b>Strobe of Pixel 4</b> Off
	4	1.6	Random Fast
	5	2.0	Random Medium
	6	2.4	Random Slow
	7 - 255	2.7 - 100	Variable Strobe (0.4Hz --> 25Hz)

### 34: RGB RGB .. SS (PIXEL = 4; STROBE = MULTIPLE)

CHANNEL	VALUE	PERCENTAGE	FUNCTION
1	0 - 255	0 - 100	Intensity Red of Pixel 1 (0% --> 100%)
2	0 - 255	0 - 100	Intensity Green of Pixel 1 (0% --> 100%)
3	0 - 255	0 - 100	Intensity Blue of Pixel 1 (0% --> 100%)
4	0 - 255	0 - 100	Intensity Red of Pixel 2 (0% --> 100%)
5	0 - 255	0 - 100	Intensity Green of Pixel 2 (0% --> 100%)
6	0 - 255	0 - 100	Intensity Blue of Pixel 2 (0% --> 100%)
7	0 - 255	0 - 100	Intensity Red of Pixel 3 (0% --> 100%)
8	0 - 255	0 - 100	Intensity Green of Pixel 3 (0% --> 100%)
9	0 - 255	0 - 100	Intensity Blue of Pixel 3 (0% --> 100%)
10	0 - 255	0 - 100	Intensity Red of Pixel 4 (0% --> 100%)
11	0 - 255	0 - 100	Intensity Green of Pixel 4 (0% --> 100%)
12	0 - 255	0 - 100	Intensity Blue of Pixel 4 (0% --> 100%)
13	0 - 3 4 5 6 7 - 255	0 - 1.2 1.6 2.0 2.4 2.7 - 100	<b>Strobe of Pixel 1</b> Off Random Fast Random Medium Random Slow Variable Strobe (0.4Hz --> 25Hz)
14	0 - 3 4 5 6 7 - 255	0 - 1.2 1.6 2.0 2.4 2.7 - 100	<b>Strobe of Pixel 2</b> Off Random Fast Random Medium Random Slow Variable Strobe (0.4Hz --> 25Hz)
15	0 - 3 4 5 6 7 - 255	0 - 1.2 1.6 2.0 2.4 2.7 - 100	<b>Strobe of Pixel 3</b> Off Random Fast Random Medium Random Slow Variable Strobe (0.4Hz --> 25Hz)
16	0 - 3 4 5 6 7 - 255	0 - 1.2 1.6 2.0 2.4 2.7 - 100	<b>Strobe of Pixel 4</b> Off Random Fast Random Medium Random Slow Variable Strobe (0.4Hz --> 25Hz)



### 35: RGBWS RGBWS (PIXEL = 4; STROBE = MULTIPLE)

CHANNEL	VALUE	PERCENTAGE	FUNCTION
1	0 - 255	0 - 100	Intensity Red of Pixel 1 (0% --> 100%)
2	0 - 255	0 - 100	Intensity Green of Pixel 1 (0% --> 100%)
3	0 - 255	0 - 100	Intensity Blue of Pixel 1 (0% --> 100%)
4	0 - 255	0 - 100	Intensity Emulated White of Pixel 1(0% --> 100%)
5	0 - 3	0 - 1.2	<b>Strobe of Pixel 1</b> Off
	4	1.6	Random Fast
	5	2.0	Random Medium
	6	2.4	Random Slow
	7 - 255	2.7 - 100	Variable Strobe (0.4Hz --> 25Hz)
6	0 - 255	0 - 100	Intensity Red of Pixel 2 (0% --> 100%)
7	0 - 255	0 - 100	Intensity Green of Pixel 2 (0% --> 100%)
8	0 - 255	0 - 100	Intensity Blue of Pixel 2 (0% --> 100%)
9	0 - 255	0 - 100	Intensity Emulated White of Pixel 2 (0% --> 100%)
10	0 - 3	0 - 1.2	<b>Strobe of Pixel 2</b> Off
	4	1.6	Random Fast
	5	2.0	Random Medium
	6	2.4	Random Slow
	7 - 255	2.7 - 100	Variable Strobe (0.4Hz --> 25Hz)
11	0 - 255	0 - 100	Intensity Red of Pixel 3 (0% --> 100%)
12	0 - 255	0 - 100	Intensity Green of Pixel 3 (0% --> 100%)
13	0 - 255	0 - 100	Intensity Blue of Pixel 3 (0% --> 100%)
14	0 - 255	0 - 100	Intensity Emulated White of Pixel 3 (0% --> 100%)
15	0 - 3	0 - 1.2	<b>Strobe of Pixel 3</b> Off
	4	1.6	Random Fast
	5	2.0	Random Medium
	6	2.4	Random Slow
	7 - 255	2.7 - 100	Variable Strobe (0.4Hz --> 25Hz)
16	0 - 255	0 - 100	Intensity Red of Pixel 4 (0% --> 100%)
17	0 - 255	0 - 100	Intensity Green of Pixel 4 (0% --> 100%)
18	0 - 255	0 - 100	Intensity Blue of Pixel 4 (0% --> 100%)
19	0 - 255	0 - 100	Intensity Emulated White of Pixel 4 (0% --> 100%)
20	0 - 3	0 - 1.2	<b>Strobe of Pixel 4</b> Off
	4	1.6	Random Fast
	5	2.0	Random Medium
	6	2.4	Random Slow
	7 - 255	2.7 - 100	Variable Strobe (0.4Hz --> 25Hz)



### 36: RGBAWS RGBAWS (PIXEL = 4; STROBE = MULTIPLE)

CHANNEL	VALUE	PERCENTAGE	FUNCTION
1	0 - 255	0 - 100	Intensity Red of Pixel 1 (0% --> 100%)
2	0 - 255	0 - 100	Intensity Green of Pixel 1 (0% --> 100%)
3	0 - 255	0 - 100	Intensity Blue of Pixel 1 (0% --> 100%)
4	0 - 255	0 - 100	Intensity Amber of Pixel 1 (0% --> 100%)
5	0 - 255	0 - 100	Intensity Emulated White of Pixel 1(0% --> 100%)
6	0 - 3 4 5 6 7 - 255	0 - 1.2 1.6 2.0 2.4 2.7 - 100	<b>Strobe of Pixel 1</b> Off Random Fast Random Medium Random Slow Variable Strobe (0.4Hz --> 25Hz)
7	0 - 255	0 - 100	Intensity Red of Pixel 2 (0% --> 100%)
8	0 - 255	0 - 100	Intensity Green of Pixel 2 (0% --> 100%)
9	0 - 255	0 - 100	Intensity Blue of Pixel 2 (0% --> 100%)
10	0 - 255	0 - 100	Intensity Amber of Pixel 2 (0% --> 100%)
11	0 - 255	0 - 100	Intensity Emulated White of Pixel 2 (0% --> 100%)
12	0 - 3 4 5 6 7 - 255	0 - 1.2 1.6 2.0 2.4 2.7 - 100	<b>Strobe of Pixel 2</b> Off Random Fast Random Medium Random Slow Variable Strobe (0.4Hz --> 25Hz)
13	0 - 255	0 - 100	Intensity Red of Pixel 3 (0% --> 100%)
14	0 - 255	0 - 100	Intensity Green of Pixel 3 (0% --> 100%)
15	0 - 255	0 - 100	Intensity Blue of Pixel 3 (0% --> 100%)
16	0 - 255	0 - 100	Intensity Amber of Pixel 3 (0% --> 100%)
17	0 - 255	0 - 100	Intensity Emulated White of Pixel 3 (0% --> 100%)
18	0 - 3 4 5 6 7 - 255	0 - 1.2 1.6 2.0 2.4 2.7 - 100	<b>Strobe of Pixel 3</b> Off Random Fast Random Medium Random Slow Variable Strobe (0.4Hz --> 25Hz)
19	0 - 255	0 - 100	Intensity Red of Pixel 4 (0% --> 100%)
20	0 - 255	0 - 100	Intensity Green of Pixel 4 (0% --> 100%)
21	0 - 255	0 - 100	Intensity Blue of Pixel 4 (0% --> 100%)
22	0 - 255	0 - 100	Intensity Amber of Pixel 4 (0% --> 100%)
23	0 - 255	0 - 100	Intensity Emulated White of Pixel 4 (0% --> 100%)
24	0 - 3 4 5 6 7 - 255	0 - 1.2 1.6 2.0 2.4 2.7 - 100	<b>Strobe of Pixel 4</b> Off Random Fast Random Medium Random Slow Variable Strobe (0.4Hz --> 25Hz)

### 37: DIM RGBS DIM RGBS (PIXEL = 4; STROBE = MULTIPLE)

CHANNEL	VALUE	PERCENTAGE	FUNCTION
1	0 - 255	0 - 100	<b>Dimmer of Pixel 1</b> (closed --> open)
2	0 - 255	0 - 100	<b>Intensity Red of Pixel 1</b> (0% --> 100%)
3	0 - 255	0 - 100	<b>Intensity Green of Pixel 1</b> (0% --> 100%)
4	0 - 255	0 - 100	<b>Intensity Blue of Pixel 1</b> (0% --> 100%)
5	0 - 3 4 5 6 7 - 255	0 - 1.2 1.6 2.0 2.4 2.7 - 100	<b>Strobe of Pixel 1</b> Off Random Fast Random Medium Random Slow Variable Strobe (0.4Hz --> 25Hz)
6	0 - 255	0 - 100	<b>Dimmer of Pixel 2</b> (closed --> open)
7	0 - 255	0 - 100	<b>Intensity Red of Pixel 2</b> (0% --> 100%)
8	0 - 255	0 - 100	<b>Intensity Green of Pixel 2</b> (0% --> 100%)
9	0 - 255	0 - 100	<b>Intensity Blue of Pixel 2</b> (0% --> 100%)
10	0 - 3 4 5 6 7 - 255	0 - 1.2 1.6 2.0 2.4 2.7 - 100	<b>Strobe of Pixel 2</b> Off Random Fast Random Medium Random Slow Variable Strobe (0.4Hz --> 25Hz)
11	0 - 255	0 - 100	<b>Dimmer of Pixel 3</b> (closed --> open)
12	0 - 255	0 - 100	<b>Intensity Red of Pixel 3</b> (0% --> 100%)
13	0 - 255	0 - 100	<b>Intensity Green of Pixel 3</b> (0% --> 100%)
14	0 - 255	0 - 100	<b>Intensity Blue of Pixel 3</b> (0% --> 100%)
15	0 - 3 4 5 6 7 - 255	0 - 1.2 1.6 2.0 2.4 2.7 - 100	<b>Strobe of Pixel 3</b> Off Random Fast Random Medium Random Slow Variable Strobe (0.4Hz --> 25Hz)
16	0 - 255	0 - 100	<b>Dimmer of Pixel 4</b> (closed --> open)
17	0 - 255	0 - 100	<b>Intensity Red of Pixel 4</b> (0% --> 100%)
18	0 - 255	0 - 100	<b>Intensity Green of Pixel 4</b> (0% --> 100%)
19	0 - 255	0 - 100	<b>Intensity Blue of Pixel 4</b> (0% --> 100%)
20	0 - 3 4 5 6 7 - 255	0 - 1.2 1.6 2.0 2.4 2.7 - 100	<b>Strobe of Pixel 4</b> Off Random Fast Random Medium Random Slow Variable Strobe (0.4Hz --> 25Hz)

### 38: DIM RGBWS DIM RGBWS (PIXEL = 4; STROBE = MULTIPLE)

CHANNEL	VALUE	PERCENTAGE	FUNCTION
1	0 - 255	0 - 100	<b>Dimmer of Pixel 1</b> (closed --> open)
2	0 - 255	0 - 100	<b>Intensity Red of Pixel 1</b> (0% --> 100%)
3	0 - 255	0 - 100	<b>Intensity Green of Pixel 1</b> (0% --> 100%)
4	0 - 255	0 - 100	<b>Intensity Blue of Pixel 1</b> (0% --> 100%)
5	1 - 255	1 - 100	<b>Intensity Emulated White of Pixel 1</b> (0% --> 100%)
6	0 - 3 4 5 6 7 - 255	0 - 1.2 1.6 2.0 2.4 2.7 - 100	<b>Strobe of Pixel 1</b> Off Random Fast Random Medium Random Slow Variable Strobe (0.4Hz --> 25Hz)
7	0 - 255	0 - 100	<b>Dimmer of Pixel 2</b> (closed --> open)
8	0 - 255	0 - 100	<b>Intensity Red of Pixel 2</b> (0% --> 100%)
9	0 - 255	0 - 100	<b>Intensity Green of Pixel 2</b> (0% --> 100%)
10	0 - 255	0 - 100	<b>Intensity Blue of Pixel 2</b> (0% --> 100%)
11	0 - 255	0 - 100	<b>Intensity Emulated White of Pixel 2</b> (0% --> 100%)
12	0 - 3 4 5 6 7 - 255	0 - 1.2 1.6 2.0 2.4 2.7 - 100	<b>Strobe of Pixel 2</b> Off Random Fast Random Medium Random Slow Variable Strobe (0.4Hz --> 25Hz)
13	0 - 255	0 - 100	<b>Dimmer of Pixel 3</b> (closed --> open)
14	0 - 255	0 - 100	<b>Intensity Red of Pixel 3</b> (0% --> 100%)
15	0 - 255	0 - 100	<b>Intensity Green of Pixel 3</b> (0% --> 100%)
16	0 - 255	0 - 100	<b>Intensity Blue of Pixel 3</b> (0% --> 100%)
17	0 - 255	0 - 100	<b>Intensity Emulated White of Pixel 3</b> (0% --> 100%)
18	0 - 3 4 5 6 7 - 255	0 - 1.2 1.6 2.0 2.4 2.7 - 100	<b>Strobe of Pixel 3</b> Off Random Fast Random Medium Random Slow Variable Strobe (0.4Hz --> 25Hz)
19	0 - 255	0 - 100	<b>Dimmer of Pixel 4</b> (closed --> open)
20	0 - 255	0 - 100	<b>Intensity Red of Pixel 4</b> (0% --> 100%)
21	0 - 255	0 - 100	<b>Intensity Green of Pixel 4</b> (0% --> 100%)
22	0 - 255	0 - 100	<b>Intensity Blue of Pixel 4</b> (0% --> 100%)
23	0 - 255	0 - 100	<b>Intensity Emulated White of Pixel 4</b> (0% --> 100%)
24	0 - 3 4 5 6 7 - 255	0 - 1.2 1.6 2.0 2.4 2.7 - 100	<b>Strobe of Pixel 4</b> Off Random Fast Random Medium Random Slow Variable Strobe (0.4Hz --> 25Hz)

### 39: DIM RGBAWS DIM RGBAWS (PIXEL = 4; STROBE = MULTIPLE)

CHANNEL	VALUE	PERCENTAGE	FUNCTION
1	0 - 255	0 - 100	<b>Dimmer of Pixel 1</b> (closed --> open)
2	0 - 255	0 - 100	<b>Intensity Red of Pixel 1</b> (0% --> 100%)
3	0 - 255	0 - 100	<b>Intensity Green of Pixel 1</b> (0% --> 100%)
4	0 - 255	0 - 100	<b>Intensity Blue of Pixel 1</b> (0% --> 100%)
5	0 - 255	0 - 100	<b>Intensity Amber of Pixel 1</b> (0% --> 100%)
6	1 - 255	1 - 100	<b>Intensity Emulated White of Pixel 1</b> (0% --> 100%)
7	0 - 3 4 5 6 7 - 255	0 - 1.2 1.6 2.0 2.4 2.7 - 100	<b>Strobe of Pixel 1</b> Off Random Fast Random Medium Random Slow Variable Strobe (0.4Hz --> 25Hz)
8	0 - 255	0 - 100	<b>Dimmer of Pixel 2</b> (closed --> open)
9	0 - 255	0 - 100	<b>Intensity Red of Pixel 2</b> (0% --> 100%)
10	0 - 255	0 - 100	<b>Intensity Green of Pixel 2</b> (0% --> 100%)
11	0 - 255	0 - 100	<b>Intensity Blue of Pixel 2</b> (0% --> 100%)
12	0 - 255	0 - 100	<b>Intensity Amber of Pixel 2</b> (0% --> 100%)
13	0 - 255	0 - 100	<b>Intensity Emulated White of Pixel 2</b> (0% --> 100%)
14	0 - 3 4 5 6 7 - 255	0 - 1.2 1.6 2.0 2.4 2.7 - 100	<b>Strobe of Pixel 2</b> Off Random Fast Random Medium Random Slow Variable Strobe (0.4Hz --> 25Hz)
15	0 - 255	0 - 100	<b>Dimmer of Pixel 3</b> (closed --> open)
16	0 - 255	0 - 100	<b>Intensity Red of Pixel 3</b> (0% --> 100%)
17	0 - 255	0 - 100	<b>Intensity Green of Pixel 3</b> (0% --> 100%)
18	0 - 255	0 - 100	<b>Intensity Blue of Pixel 3</b> (0% --> 100%)
19	0 - 255	0 - 100	<b>Intensity Amber of Pixel 3</b> (0% --> 100%)
20	0 - 255	0 - 100	<b>Intensity Emulated White of Pixel 3</b> (0% --> 100%)
21	0 - 3 4 5 6 7 - 255	0 - 1.2 1.6 2.0 2.4 2.7 - 100	<b>Strobe of Pixel 3</b> Off Random Fast Random Medium Random Slow Variable Strobe (0.4Hz --> 25Hz)
22	0 - 255	0 - 100	<b>Dimmer of Pixel 4</b> (closed --> open)
23	0 - 255	0 - 100	<b>Intensity Red of Pixel 4</b> (0% --> 100%)
24	0 - 255	0 - 100	<b>Intensity Green of Pixel 4</b> (0% --> 100%)
25	0 - 255	0 - 100	<b>Intensity Blue of Pixel 4</b> (0% --> 100%)
26	0 - 255	0 - 100	<b>Intensity Amber of Pixel 4</b> (0% --> 100%)
27	0 - 255	0 - 100	<b>Intensity Emulated White of Pixel 4</b> (0% --> 100%)
28	0 - 3 4 5 6 7 - 255	0 - 1.2 1.6 2.0 2.4 2.7 - 100	<b>Strobe of Pixel 4</b> Off Random Fast Random Medium Random Slow Variable Strobe (0.4Hz --> 25Hz)

### 40: RGB CCT DIM IND S (PIXEL = 4; STROBE = MULTIPLE)

CHANNEL	VALUE	PERCENTAGE	FUNCTION
1	0 - 255	0 - 100	<b>Intensity Red of Pixel 1</b> (0% --> 100%)
2	0 - 255	0 - 100	<b>Intensity Green of Pixel 1</b> (0% --> 100%)
3	0 - 255	0 - 100	<b>Intensity Blue of Pixel 1</b> (0% --> 100%)
4	0 - 4 4 - 255	0 - 1.5 1.6-100	<b>Color Temperature (CCT) of Pixel 1</b> No effect Display color temperature Formula: CCT = 2000 + 20*DMX-Value Example: 50 --> 3000K 100 --> 4000K 150 --> 5000K <i>*CCT overwrites the RGB setting</i>
5	0..255	0 - 100	<b>Dimmer of Pixel 1</b> (closed --> open)
6	0..1 2..255	0 - 0.4 0.8 - 100	<b>LEE Color Gel of Pixel 1</b> No effect Display LEE color gel (full list on page 171) <i>*LEE Color Gel overwrites both, RGB and CCT</i>
7	0 - 3 4 5 6 7 - 255	0 - 1.2 1.6 2.0 2.4 2.7 - 100	<b>Strobe of Pixel 1</b> Off Random Fast Random Medium Random Slow Variable Strobe (0.4Hz --> 25Hz)
8	0 - 255	0 - 100	<b>Intensity Red of Pixel 2</b> (0% --> 100%)
9	0 - 255	0 - 100	<b>Intensity Green of Pixel 2</b> (0% --> 100%)
10	0 - 255	0 - 100	<b>Intensity Blue of Pixel 2</b> (0% --> 100%)
11	0 - 4 4 - 255	0 - 1.5 1.6-100	<b>Color Temperature (CCT) of Pixel 2</b> No effect Display color temperature Formula: CCT = 2000 + 20*DMX-Value Example: 50 --> 3000K 100 --> 4000K 150 --> 5000K <i>*CCT overwrites the RGB setting</i>
12	0..255	0 - 100	<b>Dimmer of Pixel 2</b> (closed --> open)
13	0..1 2..255	0 - 0.4 0.8 - 100	<b>LEE Color Gel of Pixel 2</b> No effect Display LEE color gel (full list on page 171) <i>*LEE Color Gel overwrites both, RGB and CCT</i>
14	0 - 3 4 5	0 - 1.2 1.6 2.0	<b>Strobe of Pixel 2</b> Off Random Fast Random Medium

	6 7 - 255	2.4 2.7 - 100	Random Slow Variable Strobe (0.4Hz --> 25Hz)
15	0 - 255	0 - 100	<b>Intensity Red of Pixel 3</b> (0% --> 100%)
16	0 - 255	0 - 100	<b>Intensity Green of Pixel 3</b> (0% --> 100%)
17	0 - 255	0 - 100	<b>Intensity Blue of Pixel 3</b> (0% --> 100%)
18	0 - 4 4 - 255	0 - 1.5 1.6-100	<b>Color Temperature (CCT) of Pixel 3</b> No effect Display color temperature Formula: $CCT = 2000 + 20 * DMX-Value$ Example:           50 --> 3000K 100 --> 4000K 150 --> 5000K <i>*CCT overwrites the RGB setting</i>
19	0..255	0 - 100	<b>Dimmer of Pixel 3</b> (closed --> open)
20	0..1 2..255	0 - 0.4 0.8 - 100	<b>LEE Color Gel of Pixel 3</b> No effect Display LEE color gel (full list on page 171) <i>*LEE Color Gel overwrites both, RGB and CCT</i>
21	0 - 3 4 5 6 7 - 255	0 - 1.2 1.6 2.0 2.4 2.7 - 100	<b>Strobe of Pixel 3</b> Off Random Fast Random Medium Random Slow Variable Strobe (0.4Hz --> 25Hz)
22	0 - 255	0 - 100	<b>Intensity Red of Pixel 4</b> (0% --> 100%)
23	0 - 255	0 - 100	<b>Intensity Green of Pixel 4</b> (0% --> 100%)
24	0 - 255	0 - 100	<b>Intensity Blue of Pixel 4</b> (0% --> 100%)
25	0 - 4 4 - 255	0 - 1.5 1.6-100	<b>Color Temperature (CCT) of Pixel 4</b> No effect Display color temperature Formula: $CCT = 2000 + 20 * DMX-Value$ Example:           50 --> 3000K 100 --> 4000K 150 --> 5000K <i>*CCT overwrites the RGB setting</i>
26	0..255	0 - 100	<b>Dimmer of Pixel 4</b> (closed --> open)
27	0..1 2..255	0 - 0.4 0.8 - 100	<b>LEE Color Gel of Pixel 4</b> No effect Display LEE color gel (full list on page 171) <i>*LEE Color Gel overwrites both, RGB and CCT</i>
28	0 - 3 4 5 6 7 - 255	0 - 1.2 1.6 2.0 2.4 2.7 - 100	<b>Strobe of Pixel 4</b> Off Random Fast Random Medium Random Slow Variable Strobe (0.4Hz --> 25Hz)

**41: RGB.RGB. (PIXEL = 16; STROBE = OFF)**

CHANNEL	VALUE	PERCENTAGE	FUNCTION
1	0 - 255	0 - 100	Intensity Red of Pixel 1 (0% --> 100%)
2	0 - 255	0 - 100	Intensity Green of Pixel 1 (0% --> 100%)
3	0 - 255	0 - 100	Intensity Blue of Pixel 1 (0% --> 100%)
4			No Effect
5	0 - 255	0 - 100	Intensity Red of Pixel 2 (0% --> 100%)
6	0 - 255	0 - 100	Intensity Green of Pixel 2 (0% --> 100%)
7	0 - 255	0 - 100	Intensity Blue of Pixel 2 (0% --> 100%)
8			No Effect
9	0 - 255	0 - 100	Intensity Red of Pixel 3 (0% --> 100%)
10	0 - 255	0 - 100	Intensity Green of Pixel 3 (0% --> 100%)
11	0 - 255	0 - 100	Intensity Blue of Pixel 3 (0% --> 100%)
12			No Effect
13	0 - 255	0 - 100	Intensity Red of Pixel 4 (0% --> 100%)
14	0 - 255	0 - 100	Intensity Green of Pixel 4 (0% --> 100%)
15	0 - 255	0 - 100	Intensity Blue of Pixel 4 (0% --> 100%)
16			No Effect
17	0 - 255	0 - 100	Intensity Red of Pixel 5 (0% --> 100%)
18	0 - 255	0 - 100	Intensity Green of Pixel 5 (0% --> 100%)
19	0 - 255	0 - 100	Intensity Blue of Pixel 5 (0% --> 100%)
20			No Effect
21	0 - 255	0 - 100	Intensity Red of Pixel 6 (0% --> 100%)
22	0 - 255	0 - 100	Intensity Green of Pixel 6 (0% --> 100%)
23	0 - 255	0 - 100	Intensity Blue of Pixel 6 (0% --> 100%)
24			No Effect
25	0 - 255	0 - 100	Intensity Red of Pixel 7 (0% --> 100%)
26	0 - 255	0 - 100	Intensity Green of Pixel 7 (0% --> 100%)
27	0 - 255	0 - 100	Intensity Blue of Pixel 7 (0% --> 100%)
28			No Effect
29	0 - 255	0 - 100	Intensity Red of Pixel 8 (0% --> 100%)
30	0 - 255	0 - 100	Intensity Green of Pixel 8 (0% --> 100%)
31	0 - 255	0 - 100	Intensity Blue of Pixel 8 (0% --> 100%)
32			No Effect
33	0 - 255	0 - 100	Intensity Red of Pixel 9 (0% --> 100%)
34	0 - 255	0 - 100	Intensity Green of Pixel 9 (0% --> 100%)
35	0 - 255	0 - 100	Intensity Blue of Pixel 9 (0% --> 100%)
36			No Effect
37	0 - 255	0 - 100	Intensity Red of Pixel 10 (0% --> 100%)
38	0 - 255	0 - 100	Intensity Green of Pixel 10 (0% --> 100%)
39	0 - 255	0 - 100	Intensity Blue of Pixel 10 (0% --> 100%)
40			No Effect
41	0 - 255	0 - 100	Intensity Red of Pixel 11 (0% --> 100%)



42	0 - 255	0 - 100	<b>Intensity Green of Pixel 11 (0% --&gt; 100%)</b>
43	0 - 255	0 - 100	<b>Intensity Blue of Pixel 11 (0% --&gt; 100%)</b>
44			<b>No Effect</b>
45	0 - 255	0 - 100	<b>Intensity Red of Pixel 12 (0% --&gt; 100%)</b>
46	0 - 255	0 - 100	<b>Intensity Green of Pixel 12 (0% --&gt; 100%)</b>
47	0 - 255	0 - 100	<b>Intensity Blue of Pixel 12 (0% --&gt; 100%)</b>
48			<b>No Effect</b>
49	0 - 255	0 - 100	<b>Intensity Red of Pixel 13 (0% --&gt; 100%)</b>
50	0 - 255	0 - 100	<b>Intensity Green of Pixel 13 (0% --&gt; 100%)</b>
51	0 - 255	0 - 100	<b>Intensity Blue of Pixel 13 (0% --&gt; 100%)</b>
52			<b>No Effect</b>
53	0 - 255	0 - 100	<b>Intensity Red of Pixel 14 (0% --&gt; 100%)</b>
54	0 - 255	0 - 100	<b>Intensity Green of Pixel 14 (0% --&gt; 100%)</b>
55	0 - 255	0 - 100	<b>Intensity Blue of Pixel 14 (0% --&gt; 100%)</b>
56			<b>No Effect</b>
57	0 - 255	0 - 100	<b>Intensity Red of Pixel 15 (0% --&gt; 100%)</b>
58	0 - 255	0 - 100	<b>Intensity Green of Pixel 15 (0% --&gt; 100%)</b>
59	0 - 255	0 - 100	<b>Intensity Blue of Pixel 15 (0% --&gt; 100%)</b>
60			<b>No Effect</b>
61	0 - 255	0 - 100	<b>Intensity Red of Pixel 16 (0% --&gt; 100%)</b>
62	0 - 255	0 - 100	<b>Intensity Green of Pixel 16 (0% --&gt; 100%)</b>
63	0 - 255	0 - 100	<b>Intensity Blue of Pixel 16 (0% --&gt; 100%)</b>

## 42: RGB RGB (PIXEL = 16; STROBE = OFF)

CHANNEL	VALUE	PERCENTAGE	FUNCTION
1	0 - 255	0 - 100	Intensity Red of Pixel 1 (0% --> 100%)
2	0 - 255	0 - 100	Intensity Green of Pixel 1 (0% --> 100%)
3	0 - 255	0 - 100	Intensity Blue of Pixel 1 (0% --> 100%)
4	0 - 255	0 - 100	Intensity Red of Pixel 2 (0% --> 100%)
5	0 - 255	0 - 100	Intensity Green of Pixel 2 (0% --> 100%)
6	0 - 255	0 - 100	Intensity Blue of Pixel 2 (0% --> 100%)
7	0 - 255	0 - 100	Intensity Red of Pixel 3 (0% --> 100%)
8	0 - 255	0 - 100	Intensity Green of Pixel 3 (0% --> 100%)
9	0 - 255	0 - 100	Intensity Blue of Pixel 3 (0% --> 100%)
10	0 - 255	0 - 100	Intensity Red of Pixel 4 (0% --> 100%)
11	0 - 255	0 - 100	Intensity Green of Pixel 4 (0% --> 100%)
12	0 - 255	0 - 100	Intensity Blue of Pixel 4 (0% --> 100%)
13	0 - 255	0 - 100	Intensity Red of Pixel 5 (0% --> 100%)
14	0 - 255	0 - 100	Intensity Green of Pixel 5 (0% --> 100%)
15	0 - 255	0 - 100	Intensity Blue of Pixel 5 (0% --> 100%)
16	0 - 255	0 - 100	Intensity Red of Pixel 6 (0% --> 100%)
17	0 - 255	0 - 100	Intensity Green of Pixel 6 (0% --> 100%)
18	0 - 255	0 - 100	Intensity Blue of Pixel 6 (0% --> 100%)
19	0 - 255	0 - 100	Intensity Red of Pixel 7 (0% --> 100%)
20	0 - 255	0 - 100	Intensity Green of Pixel 7 (0% --> 100%)
21	0 - 255	0 - 100	Intensity Blue of Pixel 7 (0% --> 100%)
22	0 - 255	0 - 100	Intensity Red of Pixel 8 (0% --> 100%)
23	0 - 255	0 - 100	Intensity Green of Pixel 8 (0% --> 100%)
24	0 - 255	0 - 100	Intensity Blue of Pixel 8 (0% --> 100%)
25	0 - 255	0 - 100	Intensity Red of Pixel 9 (0% --> 100%)
26	0 - 255	0 - 100	Intensity Green of Pixel 9 (0% --> 100%)
27	0 - 255	0 - 100	Intensity Blue of Pixel 9 (0% --> 100%)
28	0 - 255	0 - 100	Intensity Red of Pixel 10 (0% --> 100%)
29	0 - 255	0 - 100	Intensity Green of Pixel 10 (0% --> 100%)
30	0 - 255	0 - 100	Intensity Blue of Pixel 10 (0% --> 100%)
31	0 - 255	0 - 100	Intensity Red of Pixel 11 (0% --> 100%)
32	0 - 255	0 - 100	Intensity Green of Pixel 11 (0% --> 100%)
33	0 - 255	0 - 100	Intensity Blue of Pixel 11 (0% --> 100%)
34	0 - 255	0 - 100	Intensity Red of Pixel 12 (0% --> 100%)
35	0 - 255	0 - 100	Intensity Green of Pixel 12 (0% --> 100%)
36	0 - 255	0 - 100	Intensity Blue of Pixel 12 (0% --> 100%)
37	0 - 255	0 - 100	Intensity Red of Pixel 13 (0% --> 100%)
38	0 - 255	0 - 100	Intensity Green of Pixel 13 (0% --> 100%)
39	0 - 255	0 - 100	Intensity Blue of Pixel 13 (0% --> 100%)
40	0 - 255	0 - 100	Intensity Red of Pixel 14 (0% --> 100%)
41	0 - 255	0 - 100	Intensity Green of Pixel 14 (0% --> 100%)



42	0 - 255	0 - 100	<b>Intensity Blue of Pixel 14 (0% --&gt; 100%)</b>
43	0 - 255	0 - 100	<b>Intensity Red of Pixel 15 (0% --&gt; 100%)</b>
44	0 - 255	0 - 100	<b>Intensity Green of Pixel 15 (0% --&gt; 100%)</b>
45	0 - 255	0 - 100	<b>Intensity Blue of Pixel 15 (0% --&gt; 100%)</b>
46	0 - 255	0 - 100	<b>Intensity Red of Pixel 16 (0% --&gt; 100%)</b>
47	0 - 255	0 - 100	<b>Intensity Green of Pixel 16 (0% --&gt; 100%)</b>
48	0 - 255	0 - 100	<b>Intensity Blue of Pixel 16 (0% --&gt; 100%)</b>

### 43: RGBW RGBW (PIXEL = 16; STROBE = OFF)

CHANNEL	VALUE	PERCENTAGE	FUNCTION
1	0 - 255	0 - 100	Intensity Red of Pixel 1 (0% --> 100%)
2	0 - 255	0 - 100	Intensity Green of Pixel 1 (0% --> 100%)
3	0 - 255	0 - 100	Intensity Blue of Pixel 1 (0% --> 100%)
4	0 - 255	0 - 100	Intensity Emulated White of Pixel 1 (0% --> 100%)
5	0 - 255	0 - 100	Intensity Red of Pixel 2 (0% --> 100%)
6	0 - 255	0 - 100	Intensity Green of Pixel 2 (0% --> 100%)
7	0 - 255	0 - 100	Intensity Blue of Pixel 2 (0% --> 100%)
8	0 - 255	0 - 100	Intensity Emulated White of Pixel 2 (0% --> 100%)
9	0 - 255	0 - 100	Intensity Red of Pixel 3 (0% --> 100%)
10	0 - 255	0 - 100	Intensity Green of Pixel 3 (0% --> 100%)
11	0 - 255	0 - 100	Intensity Blue of Pixel 3 (0% --> 100%)
12	0 - 255	0 - 100	Intensity Emulated White of Pixel 3 (0% --> 100%)
13	0 - 255	0 - 100	Intensity Red of Pixel 4 (0% --> 100%)
14	0 - 255	0 - 100	Intensity Green of Pixel 4 (0% --> 100%)
15	0 - 255	0 - 100	Intensity Blue of Pixel 4 (0% --> 100%)
16	0 - 255	0 - 100	Intensity Emulated White of Pixel 4 (0% --> 100%)
17	0 - 255	0 - 100	Intensity Red of Pixel 5 (0% --> 100%)
18	0 - 255	0 - 100	Intensity Green of Pixel 5 (0% --> 100%)
19	0 - 255	0 - 100	Intensity Blue of Pixel 5 (0% --> 100%)
20	0 - 255	0 - 100	Intensity Emulated White of Pixel 5 (0% --> 100%)
21	0 - 255	0 - 100	Intensity Red of Pixel 6 (0% --> 100%)
22	0 - 255	0 - 100	Intensity Green of Pixel 6 (0% --> 100%)
23	0 - 255	0 - 100	Intensity Blue of Pixel 6 (0% --> 100%)
24	0 - 255	0 - 100	Intensity Emulated White of Pixel 6 (0% --> 100%)
25	0 - 255	0 - 100	Intensity Red of Pixel 7 (0% --> 100%)
26	0 - 255	0 - 100	Intensity Green of Pixel 7 (0% --> 100%)
27	0 - 255	0 - 100	Intensity Blue of Pixel 7 (0% --> 100%)
28	0 - 255	0 - 100	Intensity Emulated White of Pixel 7 (0% --> 100%)
29	0 - 255	0 - 100	Intensity Red of Pixel 8 (0% --> 100%)
30	0 - 255	0 - 100	Intensity Green of Pixel 8 (0% --> 100%)
31	0 - 255	0 - 100	Intensity Blue of Pixel 8 (0% --> 100%)
32	0 - 255	0 - 100	Intensity Emulated White of Pixel 8 (0% --> 100%)
33	0 - 255	0 - 100	Intensity Red of Pixel 9 (0% --> 100%)
34	0 - 255	0 - 100	Intensity Green of Pixel 9 (0% --> 100%)
35	0 - 255	0 - 100	Intensity Blue of Pixel 9 (0% --> 100%)
36	0 - 255	0 - 100	Intensity Emulated White of Pixel 9 (0% --> 100%)
37	0 - 255	0 - 100	Intensity Red of Pixel 10 (0% --> 100%)
38	0 - 255	0 - 100	Intensity Green of Pixel 10 (0% --> 100%)
39	0 - 255	0 - 100	Intensity Blue of Pixel 10 (0% --> 100%)
40	0 - 255	0 - 100	Intensity Emulated White of Pixel 10 (0% --> 100%)
41	0 - 255	0 - 100	Intensity Red of Pixel 11 (0% --> 100%)



42	0 - 255	0 - 100	<b>Intensity Green of Pixel 11 (0% --&gt; 100%)</b>
43	0 - 255	0 - 100	<b>Intensity Blue of Pixel 11 (0% --&gt; 100%)</b>
44	0 - 255	0 - 100	<b>Intensity Emulated White of Pixel 11 (0% --&gt; 100%)</b>
45	0 - 255	0 - 100	<b>Intensity Red of Pixel 12 (0% --&gt; 100%)</b>
46	0 - 255	0 - 100	<b>Intensity Green of Pixel 12 (0% --&gt; 100%)</b>
47	0 - 255	0 - 100	<b>Intensity Blue of Pixel 12 (0% --&gt; 100%)</b>
48	0 - 255	0 - 100	<b>Intensity Emulated White of Pixel 12 (0% --&gt; 100%)</b>
49	0 - 255	0 - 100	<b>Intensity Red of Pixel 13 (0% --&gt; 100%)</b>
50	0 - 255	0 - 100	<b>Intensity Green of Pixel 13 (0% --&gt; 100%)</b>
51	0 - 255	0 - 100	<b>Intensity Blue of Pixel 13 (0% --&gt; 100%)</b>
52	0 - 255	0 - 100	<b>Intensity Emulated White of Pixel 13 (0% --&gt; 100%)</b>
53	0 - 255	0 - 100	<b>Intensity Red of Pixel 14 (0% --&gt; 100%)</b>
54	0 - 255	0 - 100	<b>Intensity Green of Pixel 14 (0% --&gt; 100%)</b>
55	0 - 255	0 - 100	<b>Intensity Blue of Pixel 14 (0% --&gt; 100%)</b>
56	0 - 255	0 - 100	<b>Intensity Emulated White of Pixel 14 (0% --&gt; 100%)</b>
57	0 - 255	0 - 100	<b>Intensity Red of Pixel 15 (0% --&gt; 100%)</b>
58	0 - 255	0 - 100	<b>Intensity Green of Pixel 15 (0% --&gt; 100%)</b>
59	0 - 255	0 - 100	<b>Intensity Blue of Pixel 15 (0% --&gt; 100%)</b>
60	0 - 255	0 - 100	<b>Intensity Emulated White of Pixel 15 (0% --&gt; 100%)</b>
61	0 - 255	0 - 100	<b>Intensity Red of Pixel 16 (0% --&gt; 100%)</b>
62	0 - 255	0 - 100	<b>Intensity Green of Pixel 16 (0% --&gt; 100%)</b>
63	0 - 255	0 - 100	<b>Intensity Blue of Pixel 16 (0% --&gt; 100%)</b>
64	0 - 255	0 - 100	<b>Intensity Emulated White of Pixel 16 (0% --&gt; 100%)</b>



#### 44: RGBAW RGBAW (PIXEL = 16; STROBE = OFF)

CHANNEL	VALUE	PERCENTAGE	FUNCTION
1	0 - 255	0 - 100	Intensity Red of Pixel 1 (0% --> 100%)
2	0 - 255	0 - 100	Intensity Green of Pixel 1 (0% --> 100%)
3	0 - 255	0 - 100	Intensity Blue of Pixel 1 (0% --> 100%)
4	0 - 255	0 - 100	Intensity Amber of Pixel 1 (0% --> 100%)
5	0 - 255	0 - 100	Intensity Emulated White of Pixel 1 (0% --> 100%)
6	0 - 255	0 - 100	Intensity Red of Pixel 2 (0% --> 100%)
7	0 - 255	0 - 100	Intensity Green of Pixel 2 (0% --> 100%)
8	0 - 255	0 - 100	Intensity Blue of Pixel 2 (0% --> 100%)
9	0 - 255	0 - 100	Intensity Amber of Pixel 2 (0% --> 100%)
10	0 - 255	0 - 100	Intensity Emulated White of Pixel 2 (0% --> 100%)
11	0 - 255	0 - 100	Intensity Red of Pixel 3 (0% --> 100%)
12	0 - 255	0 - 100	Intensity Green of Pixel 3 (0% --> 100%)
13	0 - 255	0 - 100	Intensity Blue of Pixel 3 (0% --> 100%)
14	0 - 255	0 - 100	Intensity Amber of Pixel 3 (0% --> 100%)
15	0 - 255	0 - 100	Intensity Emulated White of Pixel 3 (0% --> 100%)
16	0 - 255	0 - 100	Intensity Red of Pixel 4 (0% --> 100%)
17	0 - 255	0 - 100	Intensity Green of Pixel 4 (0% --> 100%)
18	0 - 255	0 - 100	Intensity Blue of Pixel 4 (0% --> 100%)
19	0 - 255	0 - 100	Intensity Amber of Pixel 4 (0% --> 100%)
20	0 - 255	0 - 100	Intensity Emulated White of Pixel 4 (0% --> 100%)
21	0 - 255	0 - 100	Intensity Red of Pixel 5 (0% --> 100%)
22	0 - 255	0 - 100	Intensity Green of Pixel 5 (0% --> 100%)
23	0 - 255	0 - 100	Intensity Blue of Pixel 5 (0% --> 100%)
24	0 - 255	0 - 100	Intensity Amber of Pixel 5 (0% --> 100%)
25	0 - 255	0 - 100	Intensity Emulated White of Pixel 5 (0% --> 100%)
26	0 - 255	0 - 100	Intensity Red of Pixel 6 (0% --> 100%)
27	0 - 255	0 - 100	Intensity Green of Pixel 6 (0% --> 100%)
28	0 - 255	0 - 100	Intensity Blue of Pixel 6 (0% --> 100%)
29	0 - 255	0 - 100	Intensity Amber of Pixel 6 (0% --> 100%)
30	0 - 255	0 - 100	Intensity Emulated White of Pixel 6 (0% --> 100%)
31	0 - 255	0 - 100	Intensity Red of Pixel 7 (0% --> 100%)
32	0 - 255	0 - 100	Intensity Green of Pixel 7 (0% --> 100%)
33	0 - 255	0 - 100	Intensity Blue of Pixel 7 (0% --> 100%)
34	0 - 255	0 - 100	Intensity Amber of Pixel 7 (0% --> 100%)
35	0 - 255	0 - 100	Intensity Emulated White of Pixel 7 (0% --> 100%)
36	0 - 255	0 - 100	Intensity Red of Pixel 8 (0% --> 100%)
37	0 - 255	0 - 100	Intensity Green of Pixel 8 (0% --> 100%)
38	0 - 255	0 - 100	Intensity Blue of Pixel 8 (0% --> 100%)
39	0 - 255	0 - 100	Intensity Amber of Pixel 8 (0% --> 100%)
40	0 - 255	0 - 100	Intensity Emulated White of Pixel 8 (0% --> 100%)
41	0 - 255	0 - 100	Intensity Red of Pixel 9 (0% --> 100%)



42	0 - 255	0 - 100	<b>Intensity Green of Pixel 9 (0% --&gt; 100%)</b>
43	0 - 255	0 - 100	<b>Intensity Blue of Pixel 9 (0% --&gt; 100%)</b>
44	0 - 255	0 - 100	<b>Intensity Amber of Pixel 9 (0% --&gt; 100%)</b>
45	0 - 255	0 - 100	<b>Intensity Emulated White of Pixel 9 (0% --&gt; 100%)</b>
46	0 - 255	0 - 100	<b>Intensity Red of Pixel 10 (0% --&gt; 100%)</b>
47	0 - 255	0 - 100	<b>Intensity Green of Pixel 10 (0% --&gt; 100%)</b>
48	0 - 255	0 - 100	<b>Intensity Blue of Pixel 10 (0% --&gt; 100%)</b>
49	0 - 255	0 - 100	<b>Intensity Amber of Pixel 10 (0% --&gt; 100%)</b>
50	0 - 255	0 - 100	<b>Intensity Emulated White of Pixel 10 (0% --&gt; 100%)</b>
51	0 - 255	0 - 100	<b>Intensity Red of Pixel 11 (0% --&gt; 100%)</b>
52	0 - 255	0 - 100	<b>Intensity Green of Pixel 11 (0% --&gt; 100%)</b>
53	0 - 255	0 - 100	<b>Intensity Blue of Pixel 11 (0% --&gt; 100%)</b>
54	0 - 255	0 - 100	<b>Intensity Amber of Pixel 11 (0% --&gt; 100%)</b>
55	0 - 255	0 - 100	<b>Intensity Emulated White of Pixel 11 (0% --&gt; 100%)</b>
56	0 - 255	0 - 100	<b>Intensity Red of Pixel 12 (0% --&gt; 100%)</b>
57	0 - 255	0 - 100	<b>Intensity Green of Pixel 12 (0% --&gt; 100%)</b>
58	0 - 255	0 - 100	<b>Intensity Blue of Pixel 12 (0% --&gt; 100%)</b>
59	0 - 255	0 - 100	<b>Intensity Amber of Pixel 12 (0% --&gt; 100%)</b>
60	0 - 255	0 - 100	<b>Intensity Emulated White of Pixel 12 (0% --&gt; 100%)</b>
61	0 - 255	0 - 100	<b>Intensity Red of Pixel 13 (0% --&gt; 100%)</b>
62	0 - 255	0 - 100	<b>Intensity Green of Pixel 13 (0% --&gt; 100%)</b>
63	0 - 255	0 - 100	<b>Intensity Blue of Pixel 13 (0% --&gt; 100%)</b>
64	0 - 255	0 - 100	<b>Intensity Amber of Pixel 13 (0% --&gt; 100%)</b>
65	0 - 255	0 - 100	<b>Intensity Emulated White of Pixel 13 (0% --&gt; 100%)</b>
66	0 - 255	0 - 100	<b>Intensity Red of Pixel 14 (0% --&gt; 100%)</b>
67	0 - 255	0 - 100	<b>Intensity Green of Pixel 14 (0% --&gt; 100%)</b>
68	0 - 255	0 - 100	<b>Intensity Blue of Pixel 14 (0% --&gt; 100%)</b>
69	0 - 255	0 - 100	<b>Intensity Amber of Pixel 14 (0% --&gt; 100%)</b>
70	0 - 255	0 - 100	<b>Intensity Emulated White of Pixel 14 (0% --&gt; 100%)</b>
71	0 - 255	0 - 100	<b>Intensity Red of Pixel 15 (0% --&gt; 100%)</b>
72	0 - 255	0 - 100	<b>Intensity Green of Pixel 15 (0% --&gt; 100%)</b>
73	0 - 255	0 - 100	<b>Intensity Blue of Pixel 15 (0% --&gt; 100%)</b>
74	0 - 255	0 - 100	<b>Intensity Amber of Pixel 15 (0% --&gt; 100%)</b>
75	0 - 255	0 - 100	<b>Intensity Emulated White of Pixel 15 (0% --&gt; 100%)</b>
76	0 - 255	0 - 100	<b>Intensity Red of Pixel 16 (0% --&gt; 100%)</b>
77	0 - 255	0 - 100	<b>Intensity Green of Pixel 16 (0% --&gt; 100%)</b>
78	0 - 255	0 - 100	<b>Intensity Blue of Pixel 16 (0% --&gt; 100%)</b>
79	0 - 255	0 - 100	<b>Intensity Amber of Pixel 16 (0% --&gt; 100%)</b>
80	0 - 255	0 - 100	<b>Intensity Emulated White of Pixel 16 (0% --&gt; 100%)</b>

### 45: DIM RGB DIM RGB (PIXEL = 16; STROBE = OFF)

CHANNEL	VALUE	PERCENTAGE	FUNCTION
1	0..255	0 - 100	Dimmer of Pixel 1 (closed --> open)
2	0 - 255	0 - 100	Intensity Red of Pixel 1 (0% --> 100%)
3	0 - 255	0 - 100	Intensity Green of Pixel 1 (0% --> 100%)
4	0 - 255	0 - 100	Intensity Blue of Pixel 1 (0% --> 100%)
5	0 - 255	0 - 100	Dimmer of Pixel 2 (closed --> open)
6	0 - 255	0 - 100	Intensity Red of Pixel 2 (0% --> 100%)
7	0 - 255	0 - 100	Intensity Green of Pixel 2 (0% --> 100%)
8	0 - 255	0 - 100	Intensity Blue of Pixel 2 (0% --> 100%)
9	0 - 255	0 - 100	Dimmer of Pixel 3 (closed --> open)
10	0 - 255	0 - 100	Intensity Red of Pixel 3 (0% --> 100%)
11	0 - 255	0 - 100	Intensity Green of Pixel 3 (0% --> 100%)
12	0 - 255	0 - 100	Intensity Blue of Pixel 3 (0% --> 100%)
13	0 - 255	0 - 100	Dimmer of Pixel 4 (closed --> open)
14	0 - 255	0 - 100	Intensity Red of Pixel 4 (0% --> 100%)
15	0 - 255	0 - 100	Intensity Green of Pixel 4 (0% --> 100%)
16	0 - 255	0 - 100	Intensity Blue of Pixel 4 (0% --> 100%)
17	0 - 255	0 - 100	Dimmer of Pixel 5 (closed --> open)
18	0 - 255	0 - 100	Intensity Red of Pixel 5 (0% --> 100%)
19	0 - 255	0 - 100	Intensity Green of Pixel 5 (0% --> 100%)
20	0 - 255	0 - 100	Intensity Blue of Pixel 5 (0% --> 100%)
21	0 - 255	0 - 100	Dimmer of Pixel 6 (closed --> open)
22	0 - 255	0 - 100	Intensity Red of Pixel 6 (0% --> 100%)
23	0 - 255	0 - 100	Intensity Green of Pixel 6 (0% --> 100%)
24	0 - 255	0 - 100	Intensity Blue of Pixel 6 (0% --> 100%)
25	0 - 255	0 - 100	Dimmer of Pixel 7 (closed --> open)
26	0 - 255	0 - 100	Intensity Red of Pixel 7 (0% --> 100%)
27	0 - 255	0 - 100	Intensity Green of Pixel 7 (0% --> 100%)
28	0 - 255	0 - 100	Intensity Blue of Pixel 7 (0% --> 100%)
29	0 - 255	0 - 100	Dimmer of Pixel 8 (closed --> open)
30	0 - 255	0 - 100	Intensity Red of Pixel 8 (0% --> 100%)
31	0 - 255	0 - 100	Intensity Green of Pixel 8 (0% --> 100%)
32	0 - 255	0 - 100	Intensity Blue of Pixel 8 (0% --> 100%)
33	0 - 255	0 - 100	Dimmer of Pixel 9 (closed --> open)
34	0 - 255	0 - 100	Intensity Red of Pixel 9 (0% --> 100%)
35	0 - 255	0 - 100	Intensity Green of Pixel 9 (0% --> 100%)
36	0 - 255	0 - 100	Intensity Blue of Pixel 9 (0% --> 100%)
37	0 - 255	0 - 100	Dimmer of Pixel 10 (closed --> open)
38	0 - 255	0 - 100	Intensity Red of Pixel 10 (0% --> 100%)
39	0 - 255	0 - 100	Intensity Green of Pixel 10 (0% --> 100%)
40	0 - 255	0 - 100	Intensity Blue of Pixel 10 (0% --> 100%)
41	0 - 255	0 - 100	Dimmer of Pixel 11 (closed --> open)



42	0 - 255	0 - 100	<b>Intensity Red of Pixel 11 (0% --&gt; 100%)</b>
43	0 - 255	0 - 100	<b>Intensity Green of Pixel 11 (0% --&gt; 100%)</b>
44	0 - 255	0 - 100	<b>Intensity Blue of Pixel 11 (0% --&gt; 100%)</b>
45	0 - 255	0 - 100	<b>Dimmer of Pixel 12 (closed --&gt; open)</b>
46	0 - 255	0 - 100	<b>Intensity Red of Pixel 12 (0% --&gt; 100%)</b>
47	0 - 255	0 - 100	<b>Intensity Green of Pixel 12 (0% --&gt; 100%)</b>
48	0 - 255	0 - 100	<b>Intensity Blue of Pixel 12 (0% --&gt; 100%)</b>
49	0 - 255	0 - 100	<b>Dimmer of Pixel 13 (closed --&gt; open)</b>
50	0 - 255	0 - 100	<b>Intensity Red of Pixel 13 (0% --&gt; 100%)</b>
51	0 - 255	0 - 100	<b>Intensity Green of Pixel 13 (0% --&gt; 100%)</b>
52	0 - 255	0 - 100	<b>Intensity Blue of Pixel 13 (0% --&gt; 100%)</b>
53	0 - 255	0 - 100	<b>Dimmer of Pixel 14 (closed --&gt; open)</b>
54	0 - 255	0 - 100	<b>Intensity Red of Pixel 14 (0% --&gt; 100%)</b>
55	0 - 255	0 - 100	<b>Intensity Green of Pixel 14 (0% --&gt; 100%)</b>
56	0 - 255	0 - 100	<b>Intensity Blue of Pixel 14 (0% --&gt; 100%)</b>
57	0 - 255	0 - 100	<b>Dimmer of Pixel 15 (closed --&gt; open)</b>
58	0 - 255	0 - 100	<b>Intensity Red of Pixel 15 (0% --&gt; 100%)</b>
59	0 - 255	0 - 100	<b>Intensity Green of Pixel 15 (0% --&gt; 100%)</b>
60	0 - 255	0 - 100	<b>Intensity Blue of Pixel 15 (0% --&gt; 100%)</b>
61	0 - 255	0 - 100	<b>Dimmer of Pixel 16 (closed --&gt; open)</b>
62	0 - 255	0 - 100	<b>Intensity Red of Pixel 16 (0% --&gt; 100%)</b>
63	0 - 255	0 - 100	<b>Intensity Green of Pixel 16 (0% --&gt; 100%)</b>
64	0 - 255	0 - 100	<b>Intensity Blue of Pixel 16 (0% --&gt; 100%)</b>

**46: DIM RGBW DIM RGBW (PIXEL = 16; STROBE = OFF)**

CHANNEL	VALUE	PERCENTAGE	FUNCTION
1	0 - 255	0 - 100	Dimmer of Pixel 1 (closed --> open)
2	0 - 255	0 - 100	Intensity Red of Pixel 1 (0% --> 100%)
3	0 - 255	0 - 100	Intensity Green of Pixel 1 (0% --> 100%)
4	0 - 255	0 - 100	Intensity Blue of Pixel 1 (0% --> 100%)
5	0 - 255	0 - 100	Intensity Emulated White of Pixel 1 (0% --> 100%)
6	0 - 255	0 - 100	Dimmer of Pixel 2 (closed --> open)
7	0 - 255	0 - 100	Intensity Red of Pixel 2 (0% --> 100%)
8	0 - 255	0 - 100	Intensity Green of Pixel 2 (0% --> 100%)
9	0 - 255	0 - 100	Intensity Blue of Pixel 2 (0% --> 100%)
10	0 - 255	0 - 100	Intensity Emulated White of Pixel 2 (0% --> 100%)
11	0 - 255	0 - 100	Dimmer of Pixel 3 (closed --> open)
12	0 - 255	0 - 100	Intensity Red of Pixel 3 (0% --> 100%)
13	0 - 255	0 - 100	Intensity Green of Pixel 3 (0% --> 100%)
14	0 - 255	0 - 100	Intensity Blue of Pixel 3 (0% --> 100%)
15	0 - 255	0 - 100	Intensity Emulated White of Pixel 3 (0% --> 100%)
16	0 - 255	0 - 100	Dimmer of Pixel 4 (closed --> open)
17	0 - 255	0 - 100	Intensity Red of Pixel 4 (0% --> 100%)
18	0 - 255	0 - 100	Intensity Green of Pixel 4 (0% --> 100%)
19	0 - 255	0 - 100	Intensity Blue of Pixel 4 (0% --> 100%)
20	0 - 255	0 - 100	Intensity Emulated White of Pixel 4 (0% --> 100%)
21	0 - 255	0 - 100	Dimmer of Pixel 5 (closed --> open)
22	0 - 255	0 - 100	Intensity Red of Pixel 5 (0% --> 100%)
23	0 - 255	0 - 100	Intensity Green of Pixel 5 (0% --> 100%)
24	0 - 255	0 - 100	Intensity Blue of Pixel 5 (0% --> 100%)
25	0 - 255	0 - 100	Intensity Emulated White of Pixel 5 (0% --> 100%)
26	0 - 255	0 - 100	Dimmer of Pixel 6 (closed --> open)
27	0 - 255	0 - 100	Intensity Red of Pixel 6 (0% --> 100%)
28	0 - 255	0 - 100	Intensity Green of Pixel 6 (0% --> 100%)
29	0 - 255	0 - 100	Intensity Blue of Pixel 6 (0% --> 100%)
30	0 - 255	0 - 100	Intensity Emulated White of Pixel 6 (0% --> 100%)
31	0 - 255	0 - 100	Dimmer of Pixel 7 (closed --> open)
32	0 - 255	0 - 100	Intensity Red of Pixel 7 (0% --> 100%)
33	0 - 255	0 - 100	Intensity Green of Pixel 7 (0% --> 100%)
34	0 - 255	0 - 100	Intensity Blue of Pixel 7 (0% --> 100%)
35	0 - 255	0 - 100	Intensity Emulated White of Pixel 7 (0% --> 100%)
36	0 - 255	0 - 100	Dimmer of Pixel 8 (closed --> open)
37	0 - 255	0 - 100	Intensity Red of Pixel 8 (0% --> 100%)
38	0 - 255	0 - 100	Intensity Green of Pixel 8 (0% --> 100%)
39	0 - 255	0 - 100	Intensity Blue of Pixel 8 (0% --> 100%)
40	0 - 255	0 - 100	Intensity Emulated White of Pixel 8 (0% --> 100%)
41	0 - 255	0 - 100	Dimmer of Pixel 9 (closed --> open)



42	0 - 255	0 - 100	<b>Intensity Red of Pixel 9 (0% --&gt; 100%)</b>
43	0 - 255	0 - 100	<b>Intensity Green of Pixel 9 (0% --&gt; 100%)</b>
44	0 - 255	0 - 100	<b>Intensity Blue of Pixel 9 (0% --&gt; 100%)</b>
45	0 - 255	0 - 100	<b>Intensity Emulated White of Pixel 9 (0% --&gt; 100%)</b>
46	0 - 255	0 - 100	<b>Dimmer of Pixel 10 (closed --&gt; open)</b>
47	0 - 255	0 - 100	<b>Intensity Red of Pixel 10 (0% --&gt; 100%)</b>
48	0 - 255	0 - 100	<b>Intensity Green of Pixel 10 (0% --&gt; 100%)</b>
49	0 - 255	0 - 100	<b>Intensity Blue of Pixel 10 (0% --&gt; 100%)</b>
50	0 - 255	0 - 100	<b>Intensity Emulated White of Pixel 10 (0% --&gt; 100%)</b>
51	0 - 255	0 - 100	<b>Dimmer of Pixel 11 (closed --&gt; open)</b>
52	0 - 255	0 - 100	<b>Intensity Red of Pixel 11 (0% --&gt; 100%)</b>
53	0 - 255	0 - 100	<b>Intensity Green of Pixel 11 (0% --&gt; 100%)</b>
54	0 - 255	0 - 100	<b>Intensity Blue of Pixel 11 (0% --&gt; 100%)</b>
55	0 - 255	0 - 100	<b>Intensity Emulated White of Pixel 11 (0% --&gt; 100%)</b>
56	0 - 255	0 - 100	<b>Dimmer of Pixel 12 (closed --&gt; open)</b>
57	0 - 255	0 - 100	<b>Intensity Red of Pixel 12 (0% --&gt; 100%)</b>
58	0 - 255	0 - 100	<b>Intensity Green of Pixel 12 (0% --&gt; 100%)</b>
59	0 - 255	0 - 100	<b>Intensity Blue of Pixel 12 (0% --&gt; 100%)</b>
60	0 - 255	0 - 100	<b>Intensity Emulated White of Pixel 12 (0% --&gt; 100%)</b>
61	0 - 255	0 - 100	<b>Dimmer of Pixel 13 (closed --&gt; open)</b>
62	0 - 255	0 - 100	<b>Intensity Red of Pixel 13 (0% --&gt; 100%)</b>
63	0 - 255	0 - 100	<b>Intensity Green of Pixel 13 (0% --&gt; 100%)</b>
64	0 - 255	0 - 100	<b>Intensity Blue of Pixel 13 (0% --&gt; 100%)</b>
65	0 - 255	0 - 100	<b>Intensity Emulated White of Pixel 13 (0% --&gt; 100%)</b>
66	0 - 255	0 - 100	<b>Dimmer of Pixel 14 (closed --&gt; open)</b>
67	0 - 255	0 - 100	<b>Intensity Red of Pixel 14 (0% --&gt; 100%)</b>
68	0 - 255	0 - 100	<b>Intensity Green of Pixel 14 (0% --&gt; 100%)</b>
69	0 - 255	0 - 100	<b>Intensity Blue of Pixel 14 (0% --&gt; 100%)</b>
70	0 - 255	0 - 100	<b>Intensity Emulated White of Pixel 14 (0% --&gt; 100%)</b>
71	0 - 255	0 - 100	<b>Dimmer of Pixel 15 (closed --&gt; open)</b>
72	0 - 255	0 - 100	<b>Intensity Red of Pixel 15 (0% --&gt; 100%)</b>
73	0 - 255	0 - 100	<b>Intensity Green of Pixel 15 (0% --&gt; 100%)</b>
74	0 - 255	0 - 100	<b>Intensity Blue of Pixel 15 (0% --&gt; 100%)</b>
75	0 - 255	0 - 100	<b>Intensity Emulated White of Pixel 15 (0% --&gt; 100%)</b>
76	0 - 255	0 - 100	<b>Dimmer of Pixel 16 (closed --&gt; open)</b>
77	0 - 255	0 - 100	<b>Intensity Red of Pixel 16 (0% --&gt; 100%)</b>
78	0 - 255	0 - 100	<b>Intensity Green of Pixel 16 (0% --&gt; 100%)</b>
79	0 - 255	0 - 100	<b>Intensity Blue of Pixel 16 (0% --&gt; 100%)</b>
80	0 - 255	0 - 100	<b>Intensity Emulated White of Pixel 16 (0% --&gt; 100%)</b>

### 47: DIM RGBAW DIM RGBAW (PIXEL = 16; STROBE = OFF)

CHANNEL	VALUE	PERCENTAGE	FUNCTION
1	0 - 255	0 - 100	Dimmer of Pixel 1 (closed --> open)
2	0 - 255	0 - 100	Intensity Red of Pixel 1 (0% --> 100%)
3	0 - 255	0 - 100	Intensity Green of Pixel 1 (0% --> 100%)
4	0 - 255	0 - 100	Intensity Blue of Pixel 1 (0% --> 100%)
5	0 - 255	0 - 100	Intensity Amber of Pixel 1 (0% --> 100%)
6	0 - 255	0 - 100	Intensity Emulated White of Pixel 1 (0% --> 100%)
7	0 - 255	0 - 100	Dimmer of Pixel 2 (closed --> open)
8	0 - 255	0 - 100	Intensity Red of Pixel 2 (0% --> 100%)
9	0 - 255	0 - 100	Intensity Green of Pixel 2 (0% --> 100%)
10	0 - 255	0 - 100	Intensity Blue of Pixel 2 (0% --> 100%)
11	0 - 255	0 - 100	Intensity Amber of Pixel 2 (0% --> 100%)
12	0 - 255	0 - 100	Intensity Emulated White of Pixel 2 (0% --> 100%)
13	0 - 255	0 - 100	Dimmer of Pixel 3 (closed --> open)
14	0 - 255	0 - 100	Intensity Red of Pixel 3 (0% --> 100%)
15	0 - 255	0 - 100	Intensity Green of Pixel 3 (0% --> 100%)
16	0 - 255	0 - 100	Intensity Blue of Pixel 3 (0% --> 100%)
17	0 - 255	0 - 100	Intensity Amber of Pixel 3 (0% --> 100%)
18	0 - 255	0 - 100	Intensity Emulated White of Pixel 3 (0% --> 100%)
19	0 - 255	0 - 100	Dimmer of Pixel 4 (closed --> open)
20	0 - 255	0 - 100	Intensity Red of Pixel 4 (0% --> 100%)
21	0 - 255	0 - 100	Intensity Green of Pixel 4 (0% --> 100%)
22	0 - 255	0 - 100	Intensity Blue of Pixel 4 (0% --> 100%)
23	0 - 255	0 - 100	Intensity Amber of Pixel 4 (0% --> 100%)
24	0 - 255	0 - 100	Intensity Emulated White of Pixel 4 (0% --> 100%)
25	0 - 255	0 - 100	Dimmer of Pixel 5 (closed --> open)
26	0 - 255	0 - 100	Intensity Red of Pixel 5 (0% --> 100%)
27	0 - 255	0 - 100	Intensity Green of Pixel 5 (0% --> 100%)
28	0 - 255	0 - 100	Intensity Blue of Pixel 5 (0% --> 100%)
29	0 - 255	0 - 100	Intensity Amber of Pixel 5 (0% --> 100%)
30	0 - 255	0 - 100	Intensity Emulated White of Pixel 5 (0% --> 100%)
31	0 - 255	0 - 100	Dimmer of Pixel 6 (closed --> open)
32	0 - 255	0 - 100	Intensity Red of Pixel 6 (0% --> 100%)
33	0 - 255	0 - 100	Intensity Green of Pixel 6 (0% --> 100%)
34	0 - 255	0 - 100	Intensity Blue of Pixel 6 (0% --> 100%)
35	0 - 255	0 - 100	Intensity Amber of Pixel 6 (0% --> 100%)
36	0 - 255	0 - 100	Intensity Emulated White of Pixel 6 (0% --> 100%)
37	0 - 255	0 - 100	Dimmer of Pixel 7 (closed --> open)
38	0 - 255	0 - 100	Intensity Red of Pixel 7 (0% --> 100%)
39	0 - 255	0 - 100	Intensity Green of Pixel 7 (0% --> 100%)
40	0 - 255	0 - 100	Intensity Blue of Pixel 7 (0% --> 100%)
41	0 - 255	0 - 100	Intensity Amber of Pixel 7 (0% --> 100%)



42	0 - 255	0 - 100	<b>Intensity Emulated White of Pixel 7 (0% --&gt; 100%)</b>
43	0 - 255	0 - 100	<b>Dimmer of Pixel 8 (closed --&gt; open)</b>
44	0 - 255	0 - 100	<b>Intensity Red of Pixel 8 (0% --&gt; 100%)</b>
45	0 - 255	0 - 100	<b>Intensity Green of Pixel 8 (0% --&gt; 100%)</b>
46	0 - 255	0 - 100	<b>Intensity Blue of Pixel 8 (0% --&gt; 100%)</b>
47	0 - 255	0 - 100	<b>Intensity Amber of Pixel 8 (0% --&gt; 100%)</b>
48	0 - 255	0 - 100	<b>Intensity Emulated White of Pixel 8 (0% --&gt; 100%)</b>
49	0 - 255	0 - 100	<b>Dimmer of Pixel 9 (closed --&gt; open)</b>
50	0 - 255	0 - 100	<b>Intensity Red of Pixel 9 (0% --&gt; 100%)</b>
51	0 - 255	0 - 100	<b>Intensity Green of Pixel 9 (0% --&gt; 100%)</b>
52	0 - 255	0 - 100	<b>Intensity Blue of Pixel 9 (0% --&gt; 100%)</b>
53	0 - 255	0 - 100	<b>Intensity Amber of Pixel 9 (0% --&gt; 100%)</b>
54	0 - 255	0 - 100	<b>Intensity Emulated White of Pixel 9 (0% --&gt; 100%)</b>
55	0 - 255	0 - 100	<b>Dimmer of Pixel 10 (closed --&gt; open)</b>
56	0 - 255	0 - 100	<b>Intensity Red of Pixel 10 (0% --&gt; 100%)</b>
57	0 - 255	0 - 100	<b>Intensity Green of Pixel 10 (0% --&gt; 100%)</b>
58	0 - 255	0 - 100	<b>Intensity Blue of Pixel 10 (0% --&gt; 100%)</b>
59	0 - 255	0 - 100	<b>Intensity Amber of Pixel 10 (0% --&gt; 100%)</b>
60	0 - 255	0 - 100	<b>Intensity Emulated White of Pixel 10 (0% --&gt; 100%)</b>
61	0 - 255	0 - 100	<b>Dimmer of Pixel 11 (closed --&gt; open)</b>
62	0 - 255	0 - 100	<b>Intensity Red of Pixel 11 (0% --&gt; 100%)</b>
63	0 - 255	0 - 100	<b>Intensity Green of Pixel 11 (0% --&gt; 100%)</b>
64	0 - 255	0 - 100	<b>Intensity Blue of Pixel 11 (0% --&gt; 100%)</b>
65	0 - 255	0 - 100	<b>Intensity Amber of Pixel 11 (0% --&gt; 100%)</b>
66	0 - 255	0 - 100	<b>Intensity Emulated White of Pixel 11 (0% --&gt; 100%)</b>
67	0 - 255	0 - 100	<b>Dimmer of Pixel 12 (closed --&gt; open)</b>
68	0 - 255	0 - 100	<b>Intensity Red of Pixel 12 (0% --&gt; 100%)</b>
69	0 - 255	0 - 100	<b>Intensity Green of Pixel 12 (0% --&gt; 100%)</b>
70	0 - 255	0 - 100	<b>Intensity Blue of Pixel 12 (0% --&gt; 100%)</b>
71	0 - 255	0 - 100	<b>Intensity Amber of Pixel 12 (0% --&gt; 100%)</b>
72	0 - 255	0 - 100	<b>Intensity Emulated White of Pixel 12 (0% --&gt; 100%)</b>
73	0 - 255	0 - 100	<b>Dimmer of Pixel 13 (closed --&gt; open)</b>
74	0 - 255	0 - 100	<b>Intensity Red of Pixel 13 (0% --&gt; 100%)</b>
75	0 - 255	0 - 100	<b>Intensity Green of Pixel 13 (0% --&gt; 100%)</b>
76	0 - 255	0 - 100	<b>Intensity Blue of Pixel 13 (0% --&gt; 100%)</b>
77	0 - 255	0 - 100	<b>Intensity Amber of Pixel 13 (0% --&gt; 100%)</b>
78	0 - 255	0 - 100	<b>Intensity Emulated White of Pixel 13 (0% --&gt; 100%)</b>
79	0 - 255	0 - 100	<b>Dimmer of Pixel 14 (closed --&gt; open)</b>
80	0 - 255	0 - 100	<b>Intensity Red of Pixel 14 (0% --&gt; 100%)</b>
81	0 - 255	0 - 100	<b>Intensity Green of Pixel 14 (0% --&gt; 100%)</b>
82	0 - 255	0 - 100	<b>Intensity Blue of Pixel 14 (0% --&gt; 100%)</b>
83	0 - 255	0 - 100	<b>Intensity Amber of Pixel 14 (0% --&gt; 100%)</b>
84	0 - 255	0 - 100	<b>Intensity Emulated White of Pixel 14 (0% --&gt; 100%)</b>
85	0 - 255	0 - 100	<b>Dimmer of Pixel 15 (closed --&gt; open)</b>



86	0 - 255	0 - 100	<b>Intensity Red of Pixel 15 (0% --&gt; 100%)</b>
87	0 - 255	0 - 100	<b>Intensity Green of Pixel 15 (0% --&gt; 100%)</b>
88	0 - 255	0 - 100	<b>Intensity Blue of Pixel 15 (0% --&gt; 100%)</b>
89	0 - 255	0 - 100	<b>Intensity Amber of Pixel 15 (0% --&gt; 100%)</b>
90	0 - 255	0 - 100	<b>Intensity Emulated White of Pixel 15 (0% --&gt; 100%)</b>
91	0 - 255	0 - 100	<b>Dimmer of Pixel 16 (closed --&gt; open)</b>
92	0 - 255	0 - 100	<b>Intensity Red of Pixel 16 (0% --&gt; 100%)</b>
93	0 - 255	0 - 100	<b>Intensity Green of Pixel 16 (0% --&gt; 100%)</b>
94	0 - 255	0 - 100	<b>Intensity Blue of Pixel 16 (0% --&gt; 100%)</b>
95	0 - 255	0 - 100	<b>Intensity Amber of Pixel 16 (0% --&gt; 100%)</b>
96	0 - 255	0 - 100	<b>Intensity Emulated White of Pixel 16 (0% --&gt; 100%)</b>

### 48: RGB CCT DIM IND (PIXEL = 16; STROBE = OFF)

CHANNEL	VALUE	PERCENTAGE	FUNCTION
1	0 - 255	0 - 100	<b>Intensity Red of Pixel 1</b> (0% --> 100%)
2	0 - 255	0 - 100	<b>Intensity Green of Pixel 1</b> (0% --> 100%)
3	0 - 255	0 - 100	<b>Intensity Blue of Pixel 1</b> (0% --> 100%)
4	0 - 4 4 - 255	0 - 1.5 1.6-100	<b>Color Temperature (CCT) of Pixel 1</b> No effect Display color temperature Formula: CCT = 2000 + 20*DMX-Value Example: 50 --> 3000K 100 --> 4000K 150 --> 5000K <i>*CCT overwrites the RGB setting</i>
5	0..255	0 - 100	<b>Dimmer of Pixel 1</b> (closed --> open)
6	0..1 2..255	0 - 0.4 0.8 - 100	<b>LEE Color Gel of Pixel 1</b> No effect Display LEE color gel (full list on page 171) <i>*LEE Color Gel overwrites both, RGB and CCT</i>
7	0 - 255	0 - 100	<b>Intensity Red of Pixel 2</b> (0% --> 100%)
8	0 - 255	0 - 100	<b>Intensity Green of Pixel 2</b> (0% --> 100%)
9	0 - 255	0 - 100	<b>Intensity Blue of Pixel 2</b> (0% --> 100%)
10	0 - 4 4 - 255	0 - 1.5 1.6-100	<b>Color Temperature (CCT) of Pixel 2</b> No effect Display color temperature Formula: CCT = 2000 + 20*DMX-Value Example: 50 --> 3000K 100 --> 4000K 150 --> 5000K <i>*CCT overwrites the RGB setting</i>
11	0..255	0 - 100	<b>Dimmer of Pixel 2</b> (closed --> open)
12	0..1 2..255	0 - 0.4 0.8 - 100	<b>LEE Color Gel of Pixel 2</b> No effect Display LEE color gel (full list on page 171) <i>*LEE Color Gel overwrites both, RGB and CCT</i>
13	0 - 255	0 - 100	<b>Intensity Red of Pixel 3</b> (0% --> 100%)
14	0 - 255	0 - 100	<b>Intensity Green of Pixel 3</b> (0% --> 100%)
15	0 - 255	0 - 100	<b>Intensity Blue of Pixel 3</b> (0% --> 100%)
16	0 - 4 4 - 255	0 - 1.5 1.6-100	<b>Color Temperature (CCT) of Pixel 3</b> No effect Display color temperature Formula: CCT = 2000 + 20*DMX-Value Example: 50 --> 3000K 100 --> 4000K 150 --> 5000K

			<i>*CCT overwrites the RGB setting</i>
17	0..255	0 - 100	<b>Dimmer of Pixel 3</b> (closed --> open)
18	0..1 2..255	0 - 0.4 0.8 - 100	<b>LEE Color Gel of Pixel 3</b> No effect Display LEE color gel (full list on page 171) <i>*LEE Color Gel overwrites both, RGB and CCT</i>
19	0 - 255	0 - 100	<b>Intensity Red of Pixel 4</b> (0% --> 100%)
20	0 - 255	0 - 100	<b>Intensity Green of Pixel 4</b> (0% --> 100%)
21	0 - 255	0 - 100	<b>Intensity Blue of Pixel 4</b> (0% --> 100%)
22	0 - 4 4 - 255	0 - 1.5 1.6-100	<b>Color Temperature (CCT) of Pixel 4</b> No effect Display color temperature Formula: CCT = 2000 + 20*DMX-Value Example:           50 --> 3000K 100 --> 4000K 150 --> 5000K <i>*CCT overwrites the RGB setting</i>
23	0..255	0 - 100	<b>Dimmer of Pixel 4</b> (closed --> open)
24	0..1 2..255	0 - 0.4 0.8 - 100	<b>LEE Color Gel of Pixel 4</b> No effect Display LEE color gel (full list on page 171) <i>*LEE Color Gel overwrites both, RGB and CCT</i>
25	0 - 255	0 - 100	<b>Intensity Red of Pixel 5</b> (0% --> 100%)
26	0 - 255	0 - 100	<b>Intensity Green of Pixel 5</b> (0% --> 100%)
27	0 - 255	0 - 100	<b>Intensity Blue of Pixel 5</b> (0% --> 100%)
28	0 - 4 4 - 255	0 - 1.5 1.6-100	<b>Color Temperature (CCT) of Pixel 5</b> No effect Display color temperature Formula: CCT = 2000 + 20*DMX-Value Example:           50 --> 3000K 100 --> 4000K 150 --> 5000K <i>*CCT overwrites the RGB setting</i>
29	0..255	0 - 100	<b>Dimmer of Pixel 5</b> (closed --> open)
30	0..1 2..255	0 - 0.4 0.8 - 100	<b>LEE Color Gel of Pixel 5</b> No effect Display LEE color gel (full list on page 171) <i>*LEE Color Gel overwrites both, RGB and CCT</i>
31	0 - 255	0 - 100	<b>Intensity Red of Pixel 6</b> (0% --> 100%)
32	0 - 255	0 - 100	<b>Intensity Green of Pixel 6</b> (0% --> 100%)
33	0 - 255	0 - 100	<b>Intensity Blue of Pixel 6</b> (0% --> 100%)
34	0 - 4 4 - 255	0 - 1.5 1.6-100	<b>Color Temperature (CCT) of Pixel 6</b> No effect Display color temperature Formula: CCT = 2000 + 20*DMX-Value

			<p>Example: 50 --&gt; 3000K 100 --&gt; 4000K 150 --&gt; 5000K</p> <p><i>*CCT overwrites the RGB setting</i></p>
35	0..255	0 - 100	<b>Dimmer of Pixel 6</b> (closed --> open)
36	0..1 2..255	0 - 0.4 0.8 - 100	<p><b>LEE Color Gel of Pixel 6</b></p> <p>No effect</p> <p>Display LEE color gel (full list on page 171)</p> <p><i>*LEE Color Gel overwrites both, RGB and CCT</i></p>
37	0 - 255	0 - 100	<b>Intensity Red of Pixel 7</b> (0% --> 100%)
38	0 - 255	0 - 100	<b>Intensity Green of Pixel 7</b> (0% --> 100%)
39	0 - 255	0 - 100	<b>Intensity Blue of Pixel 7</b> (0% --> 100%)
40	0 - 4 4 - 255	0 - 1.5 1.6-100	<p><b>Color Temperature (CCT) of Pixel 7</b></p> <p>No effect</p> <p>Display color temperature</p> <p>Formula: <math>CCT = 2000 + 20 * DMX-Value</math></p> <p>Example: 50 --&gt; 3000K 100 --&gt; 4000K 150 --&gt; 5000K</p> <p><i>*CCT overwrites the RGB setting</i></p>
41	0..255	0 - 100	<b>Dimmer of Pixel 7</b> (closed --> open)
42	0..1 2..255	0 - 0.4 0.8 - 100	<p><b>LEE Color Gel of Pixel 7</b></p> <p>No effect</p> <p>Display LEE color gel (full list on page 171)</p> <p><i>*LEE Color Gel overwrites both, RGB and CCT</i></p>
43	0 - 255	0 - 100	<b>Intensity Red of Pixel 8</b> (0% --> 100%)
44	0 - 255	0 - 100	<b>Intensity Green of Pixel 8</b> (0% --> 100%)
45	0 - 255	0 - 100	<b>Intensity Blue of Pixel 8</b> (0% --> 100%)
46	0 - 4 4 - 255	0 - 1.5 1.6-100	<p><b>Color Temperature (CCT) of Pixel 8</b></p> <p>No effect</p> <p>Display color temperature</p> <p>Formula: <math>CCT = 2000 + 20 * DMX-Value</math></p> <p>Example: 50 --&gt; 3000K 100 --&gt; 4000K 150 --&gt; 5000K</p> <p><i>*CCT overwrites the RGB setting</i></p>
47	0..255	0 - 100	<b>Dimmer of Pixel 8</b> (closed --> open)
48	0..1 2..255	0 - 0.4 0.8 - 100	<p><b>LEE Color Gel of Pixel 8</b></p> <p>No effect</p> <p>Display LEE color gel (full list on page 171)</p> <p><i>*LEE Color Gel overwrites both, RGB and CCT</i></p>
49	0 - 255	0 - 100	<b>Intensity Red of Pixel 9</b> (0% --> 100%)
50	0 - 255	0 - 100	<b>Intensity Green of Pixel 9</b> (0% --> 100%)
51	0 - 255	0 - 100	<b>Intensity Blue of Pixel 9</b> (0% --> 100%)
52			<b>Color Temperature (CCT) of Pixel 9</b>

	0 - 4 4 - 255	0 - 1.5 1.6-100	No effect Display color temperature Formula: $CCT = 2000 + 20 * DMX-Value$ Example: 50 --> 3000K 100 --> 4000K 150 --> 5000K <i>*CCT overwrites the RGB setting</i>
53	0..255	0 - 100	<b>Dimmer of Pixel 9</b> (closed --> open)
54	0..1 2..255	0 - 0.4 0.8 - 100	<b>LEE Color Gel of Pixel 9</b> No effect Display LEE color gel (full list on page 171) <i>*LEE Color Gel overwrites both, RGB and CCT</i>
55	0 - 255	0 - 100	<b>Intensity Red of Pixel 10</b> (0% --> 100%)
56	0 - 255	0 - 100	<b>Intensity Green of Pixel 10</b> (0% --> 100%)
57	0 - 255	0 - 100	<b>Intensity Blue of Pixel 10</b> (0% --> 100%)
58	0 - 4 4 - 255	0 - 1.5 1.6-100	<b>Color Temperature (CCT) of Pixel 10</b> No effect Display color temperature Formula: $CCT = 2000 + 20 * DMX-Value$ Example: 50 --> 3000K 100 --> 4000K 150 --> 5000K <i>*CCT overwrites the RGB setting</i>
59	0..255	0 - 100	<b>Dimmer of Pixel 10</b> (closed --> open)
60	0..1 2..255	0 - 0.4 0.8 - 100	<b>LEE Color Gel of Pixel 10</b> No effect Display LEE color gel (full list on page 171) <i>*LEE Color Gel overwrites both, RGB and CCT</i>
61	0 - 255	0 - 100	<b>Intensity Red of Pixel 11</b> (0% --> 100%)
62	0 - 255	0 - 100	<b>Intensity Green of Pixel 11</b> (0% --> 100%)
63	0 - 255	0 - 100	<b>Intensity Blue of Pixel 11</b> (0% --> 100%)
64	0 - 4 4 - 255	0 - 1.5 1.6-100	<b>Color Temperature (CCT) of Pixel 11</b> No effect Display color temperature Formula: $CCT = 2000 + 20 * DMX-Value$ Example: 50 --> 3000K 100 --> 4000K 150 --> 5000K <i>*CCT overwrites the RGB setting</i>
65	0..255	0 - 100	<b>Dimmer of Pixel 11</b> (closed --> open)
66	0..1 2..255	0 - 0.4 0.8 - 100	<b>LEE Color Gel of Pixel 11</b> No effect Display LEE color gel (full list on page 171) <i>*LEE Color Gel overwrites both, RGB and CCT</i>
67	0 - 255	0 - 100	<b>Intensity Red of Pixel 12</b> (0% --> 100%)

68	0 - 255	0 - 100	<b>Intensity Green of Pixel 12 (0% --&gt; 100%)</b>
69	0 - 255	0 - 100	<b>Intensity Blue of Pixel 12 (0% --&gt; 100%)</b>
70	0 - 4 4 - 255	0 - 1.5 1.6-100	<b>Color Temperature (CCT) of Pixel 12</b> No effect Display color temperature Formula: CCT = 2000 + 20*DMX-Value Example: 50 --> 3000K 100 --> 4000K 150 --> 5000K <i>*CCT overwrites the RGB setting</i>
71	0..255	0 - 100	<b>Dimmer of Pixel 12 (closed --&gt; open)</b>
72	0..1 2..255	0 - 0.4 0.8 - 100	<b>LEE Color Gel of Pixel 12</b> No effect Display LEE color gel (full list on page 171) <i>*LEE Color Gel overwrites both, RGB and CCT</i>
73	0 - 255	0 - 100	<b>Intensity Red of Pixel 13 (0% --&gt; 100%)</b>
74	0 - 255	0 - 100	<b>Intensity Green of Pixel 13 (0% --&gt; 100%)</b>
75	0 - 255	0 - 100	<b>Intensity Blue of Pixel 13 (0% --&gt; 100%)</b>
76	0 - 4 4 - 255	0 - 1.5 1.6-100	<b>Color Temperature (CCT) of Pixel 13</b> No effect Display color temperature Formula: CCT = 2000 + 20*DMX-Value Example: 50 --> 3000K 100 --> 4000K 150 --> 5000K <i>*CCT overwrites the RGB setting</i>
77	0..255	0 - 100	<b>Dimmer of Pixel 13 (closed --&gt; open)</b>
78	0..1 2..255	0 - 0.4 0.8 - 100	<b>LEE Color Gel of Pixel 13</b> No effect Display LEE color gel (full list on page 171) <i>*LEE Color Gel overwrites both, RGB and CCT</i>
79	0 - 255	0 - 100	<b>Intensity Red of Pixel 14 (0% --&gt; 100%)</b>
80	0 - 255	0 - 100	<b>Intensity Green of Pixel 14 (0% --&gt; 100%)</b>
81	0 - 255	0 - 100	<b>Intensity Blue of Pixel 14 (0% --&gt; 100%)</b>
82	0 - 4 4 - 255	0 - 1.5 1.6-100	<b>Color Temperature (CCT) of Pixel 14</b> No effect Display color temperature Formula: CCT = 2000 + 20*DMX-Value Example: 50 --> 3000K 100 --> 4000K 150 --> 5000K <i>*CCT overwrites the RGB setting</i>
83	0..255	0 - 100	<b>Dimmer of Pixel 14 (closed --&gt; open)</b>
84	0..1	0 - 0.4	<b>LEE Color Gel of Pixel 14</b> No effect

	2..255	0.8 - 100	Display LEE color gel (full list on page 171) <i>*LEE Color Gel overwrites both, RGB and CCT</i>
85	0 - 255	0 - 100	<b>Intensity Red of Pixel 15</b> (0% --> 100%)
86	0 - 255	0 - 100	<b>Intensity Green of Pixel 15</b> (0% --> 100%)
87	0 - 255	0 - 100	<b>Intensity Blue of Pixel 15</b> (0% --> 100%)
88	0 - 4 4 - 255	0 - 1.5 1.6-100	<b>Color Temperature (CCT) of Pixel 15</b> No effect Display color temperature Formula: $CCT = 2000 + 20 * DMX-Value$ Example:           50 --> 3000K 100 --> 4000K 150 --> 5000K <i>*CCT overwrites the RGB setting</i>
89	0..255	0 - 100	<b>Dimmer of Pixel 15</b> (closed --> open)
90	0..1 2..255	0 - 0.4 0.8 - 100	<b>LEE Color Gel of Pixel 15</b> No effect Display LEE color gel (full list on page 171) <i>*LEE Color Gel overwrites both, RGB and CCT</i>
91	0 - 255	0 - 100	<b>Intensity Red of Pixel 16</b> (0% --> 100%)
92	0 - 255	0 - 100	<b>Intensity Green of Pixel 16</b> (0% --> 100%)
93	0 - 255	0 - 100	<b>Intensity Blue of Pixel 16</b> (0% --> 100%)
94	0 - 4 4 - 255	0 - 1.5 1.6-100	<b>Color Temperature (CCT) of Pixel 16</b> No effect Display color temperature Formula: $CCT = 2000 + 20 * DMX-Value$ Example:           50 --> 3000K 100 --> 4000K 150 --> 5000K <i>*CCT overwrites the RGB setting</i>
95	0..255	0 - 100	<b>Dimmer of Pixel 16</b> (closed --> open)
96	0..1 2..255	0 - 0.4 0.8 - 100	<b>LEE Color Gel of Pixel 16</b> No effect Display LEE color gel (full list on page 171) <i>*LEE Color Gel overwrites both, RGB and CCT</i>

## 49: RGB.RGBS (PIXEL = 16; STROBE = SINGLE)

CHANNEL	VALUE	PERCENTAGE	FUNCTION
1	0 - 255	0 - 100	Intensity Red of Pixel 1 (0% --> 100%)
2	0 - 255	0 - 100	Intensity Green of Pixel 1 (0% --> 100%)
3	0 - 255	0 - 100	Intensity Blue of Pixel 1 (0% --> 100%)
4	0 - 3 4 5 6 7 - 255	0 - 1.2 1.6 2.0 2.4 2.7 - 100	<b>Strobe for all Pixels</b> Off Random Fast Random Medium Random Slow Variable Strobe (0.4Hz --> 25Hz)
5	0 - 255	0 - 100	Intensity Red of Pixel 2 (0% --> 100%)
6	0 - 255	0 - 100	Intensity Green of Pixel 2 (0% --> 100%)
7	0 - 255	0 - 100	Intensity Blue of Pixel 2 (0% --> 100%)
8			No Effect
9	0 - 255	0 - 100	Intensity Red of Pixel 3 (0% --> 100%)
10	0 - 255	0 - 100	Intensity Green of Pixel 3 (0% --> 100%)
11	0 - 255	0 - 100	Intensity Blue of Pixel 3 (0% --> 100%)
12			No Effect
13	0 - 255	0 - 100	Intensity Red of Pixel 4 (0% --> 100%)
14	0 - 255	0 - 100	Intensity Green of Pixel 4 (0% --> 100%)
15	0 - 255	0 - 100	Intensity Blue of Pixel 4 (0% --> 100%)
16			No Effect
17	0 - 255	0 - 100	Intensity Red of Pixel 5 (0% --> 100%)
18	0 - 255	0 - 100	Intensity Green of Pixel 5 (0% --> 100%)
19	0 - 255	0 - 100	Intensity Blue of Pixel 5 (0% --> 100%)
20			No Effect
21	0 - 255	0 - 100	Intensity Red of Pixel 6 (0% --> 100%)
22	0 - 255	0 - 100	Intensity Green of Pixel 6 (0% --> 100%)
23	0 - 255	0 - 100	Intensity Blue of Pixel 6 (0% --> 100%)
24			No Effect
25	0 - 255	0 - 100	Intensity Red of Pixel 7 (0% --> 100%)
26	0 - 255	0 - 100	Intensity Green of Pixel 7 (0% --> 100%)
27	0 - 255	0 - 100	Intensity Blue of Pixel 7 (0% --> 100%)
28			No Effect
29	0 - 255	0 - 100	Intensity Red of Pixel 8 (0% --> 100%)
30	0 - 255	0 - 100	Intensity Green of Pixel 8 (0% --> 100%)
31	0 - 255	0 - 100	Intensity Blue of Pixel 8 (0% --> 100%)
32			No Effect
33	0 - 255	0 - 100	Intensity Red of Pixel 9 (0% --> 100%)
34	0 - 255	0 - 100	Intensity Green of Pixel 9 (0% --> 100%)
35	0 - 255	0 - 100	Intensity Blue of Pixel 9 (0% --> 100%)
36			No Effect

37	0 - 255	0 - 100	<b>Intensity Red of Pixel 10 (0% --&gt; 100%)</b>
38	0 - 255	0 - 100	<b>Intensity Green of Pixel 10 (0% --&gt; 100%)</b>
39	0 - 255	0 - 100	<b>Intensity Blue of Pixel 10 (0% --&gt; 100%)</b>
40			<b>No Effect</b>
41	0 - 255	0 - 100	<b>Intensity Red of Pixel 11 (0% --&gt; 100%)</b>
42	0 - 255	0 - 100	<b>Intensity Green of Pixel 11 (0% --&gt; 100%)</b>
43	0 - 255	0 - 100	<b>Intensity Blue of Pixel 11 (0% --&gt; 100%)</b>
44			<b>No Effect</b>
45	0 - 255	0 - 100	<b>Intensity Red of Pixel 12 (0% --&gt; 100%)</b>
46	0 - 255	0 - 100	<b>Intensity Green of Pixel 12 (0% --&gt; 100%)</b>
47	0 - 255	0 - 100	<b>Intensity Blue of Pixel 12 (0% --&gt; 100%)</b>
48			<b>No Effect</b>
49	0 - 255	0 - 100	<b>Intensity Red of Pixel 13 (0% --&gt; 100%)</b>
50	0 - 255	0 - 100	<b>Intensity Green of Pixel 13 (0% --&gt; 100%)</b>
51	0 - 255	0 - 100	<b>Intensity Blue of Pixel 13 (0% --&gt; 100%)</b>
52			<b>No Effect</b>
53	0 - 255	0 - 100	<b>Intensity Red of Pixel 14 (0% --&gt; 100%)</b>
54	0 - 255	0 - 100	<b>Intensity Green of Pixel 14 (0% --&gt; 100%)</b>
55	0 - 255	0 - 100	<b>Intensity Blue of Pixel 14 (0% --&gt; 100%)</b>
56			<b>No Effect</b>
57	0 - 255	0 - 100	<b>Intensity Red of Pixel 15 (0% --&gt; 100%)</b>
58	0 - 255	0 - 100	<b>Intensity Green of Pixel 15 (0% --&gt; 100%)</b>
59	0 - 255	0 - 100	<b>Intensity Blue of Pixel 15 (0% --&gt; 100%)</b>
60			<b>No Effect</b>
61	0 - 255	0 - 100	<b>Intensity Red of Pixel 16 (0% --&gt; 100%)</b>
62	0 - 255	0 - 100	<b>Intensity Green of Pixel 16 (0% --&gt; 100%)</b>
63	0 - 255	0 - 100	<b>Intensity Blue of Pixel 16 (0% --&gt; 100%)</b>

**50: RGB RGB .. S (PIXEL = 16; STROBE = SINGLE)**

CHANNEL	VALUE	PERCENTAGE	FUNCTION
1	0 - 255	0 - 100	Intensity Red of Pixel 1 (0% --> 100%)
2	0 - 255	0 - 100	Intensity Green of Pixel 1 (0% --> 100%)
3	0 - 255	0 - 100	Intensity Blue of Pixel 1 (0% --> 100%)
4	0 - 255	0 - 100	Intensity Red of Pixel 2 (0% --> 100%)
5	0 - 255	0 - 100	Intensity Green of Pixel 2 (0% --> 100%)
6	0 - 255	0 - 100	Intensity Blue of Pixel 2 (0% --> 100%)
7	0 - 255	0 - 100	Intensity Red of Pixel 3 (0% --> 100%)
8	0 - 255	0 - 100	Intensity Green of Pixel 3 (0% --> 100%)
9	0 - 255	0 - 100	Intensity Blue of Pixel 3 (0% --> 100%)
10	0 - 255	0 - 100	Intensity Red of Pixel 4 (0% --> 100%)
11	0 - 255	0 - 100	Intensity Green of Pixel 4 (0% --> 100%)
12	0 - 255	0 - 100	Intensity Blue of Pixel 4 (0% --> 100%)
13	0 - 255	0 - 100	Intensity Red of Pixel 5 (0% --> 100%)
14	0 - 255	0 - 100	Intensity Green of Pixel 5 (0% --> 100%)
15	0 - 255	0 - 100	Intensity Blue of Pixel 5 (0% --> 100%)
16	0 - 255	0 - 100	Intensity Red of Pixel 6 (0% --> 100%)
17	0 - 255	0 - 100	Intensity Green of Pixel 6 (0% --> 100%)
18	0 - 255	0 - 100	Intensity Blue of Pixel 6 (0% --> 100%)
19	0 - 255	0 - 100	Intensity Red of Pixel 7 (0% --> 100%)
20	0 - 255	0 - 100	Intensity Green of Pixel 7 (0% --> 100%)
21	0 - 255	0 - 100	Intensity Blue of Pixel 7 (0% --> 100%)
22	0 - 255	0 - 100	Intensity Red of Pixel 8 (0% --> 100%)
23	0 - 255	0 - 100	Intensity Green of Pixel 8 (0% --> 100%)
24	0 - 255	0 - 100	Intensity Blue of Pixel 8 (0% --> 100%)
25	0 - 255	0 - 100	Intensity Red of Pixel 9 (0% --> 100%)
26	0 - 255	0 - 100	Intensity Green of Pixel 9 (0% --> 100%)
27	0 - 255	0 - 100	Intensity Blue of Pixel 9 (0% --> 100%)
28	0 - 255	0 - 100	Intensity Red of Pixel 10 (0% --> 100%)
29	0 - 255	0 - 100	Intensity Green of Pixel 10 (0% --> 100%)
30	0 - 255	0 - 100	Intensity Blue of Pixel 10 (0% --> 100%)
31	0 - 255	0 - 100	Intensity Red of Pixel 11 (0% --> 100%)
32	0 - 255	0 - 100	Intensity Green of Pixel 11 (0% --> 100%)
33	0 - 255	0 - 100	Intensity Blue of Pixel 11 (0% --> 100%)
34	0 - 255	0 - 100	Intensity Red of Pixel 12 (0% --> 100%)
35	0 - 255	0 - 100	Intensity Green of Pixel 12 (0% --> 100%)
36	0 - 255	0 - 100	Intensity Blue of Pixel 12 (0% --> 100%)
37	0 - 255	0 - 100	Intensity Red of Pixel 13 (0% --> 100%)
38	0 - 255	0 - 100	Intensity Green of Pixel 13 (0% --> 100%)
39	0 - 255	0 - 100	Intensity Blue of Pixel 13 (0% --> 100%)
40	0 - 255	0 - 100	Intensity Red of Pixel 14 (0% --> 100%)
41	0 - 255	0 - 100	Intensity Green of Pixel 14 (0% --> 100%)



42	0 - 255	0 - 100	<b>Intensity Blue of Pixel 14 (0% --&gt; 100%)</b>
43	0 - 255	0 - 100	<b>Intensity Red of Pixel 15 (0% --&gt; 100%)</b>
44	0 - 255	0 - 100	<b>Intensity Green of Pixel 15 (0% --&gt; 100%)</b>
45	0 - 255	0 - 100	<b>Intensity Blue of Pixel 15 (0% --&gt; 100%)</b>
46	0 - 255	0 - 100	<b>Intensity Red of Pixel 16 (0% --&gt; 100%)</b>
47	0 - 255	0 - 100	<b>Intensity Green of Pixel 16 (0% --&gt; 100%)</b>
48	0 - 255	0 - 100	<b>Intensity Blue of Pixel 16 (0% --&gt; 100%)</b>
49	0 - 3 4 5 6 7 - 255	0 - 1.2 1.6 2.0 2.4 2.7 - 100	<b>Strobe for all Pixels</b> Off Random Fast Random Medium Random Slow Variable Strobe (0.4Hz --> 25Hz)

### 51: RGBW RGBW .. S (PIXEL = 16; STROBE = SINGLE)

CHANNEL	VALUE	PERCENTAGE	FUNCTION
1	0 - 255	0 - 100	Intensity Red of Pixel 1 (0% --> 100%)
2	0 - 255	0 - 100	Intensity Green of Pixel 1 (0% --> 100%)
3	0 - 255	0 - 100	Intensity Blue of Pixel 1 (0% --> 100%)
4	0 - 255	0 - 100	Intensity Emulated White of Pixel 1 (0% --> 100%)
5	0 - 255	0 - 100	Intensity Red of Pixel 2 (0% --> 100%)
6	0 - 255	0 - 100	Intensity Green of Pixel 2 (0% --> 100%)
7	0 - 255	0 - 100	Intensity Blue of Pixel 2 (0% --> 100%)
8	0 - 255	0 - 100	Intensity Emulated White of Pixel 2 (0% --> 100%)
9	0 - 255	0 - 100	Intensity Red of Pixel 3 (0% --> 100%)
10	0 - 255	0 - 100	Intensity Green of Pixel 3 (0% --> 100%)
11	0 - 255	0 - 100	Intensity Blue of Pixel 3 (0% --> 100%)
12	0 - 255	0 - 100	Intensity Emulated White of Pixel 3 (0% --> 100%)
13	0 - 255	0 - 100	Intensity Red of Pixel 4 (0% --> 100%)
14	0 - 255	0 - 100	Intensity Green of Pixel 4 (0% --> 100%)
15	0 - 255	0 - 100	Intensity Blue of Pixel 4 (0% --> 100%)
16	0 - 255	0 - 100	Intensity Emulated White of Pixel 4 (0% --> 100%)
17	0 - 255	0 - 100	Intensity Red of Pixel 5 (0% --> 100%)
18	0 - 255	0 - 100	Intensity Green of Pixel 5 (0% --> 100%)
19	0 - 255	0 - 100	Intensity Blue of Pixel 5 (0% --> 100%)
20	0 - 255	0 - 100	Intensity Emulated White of Pixel 5 (0% --> 100%)
21	0 - 255	0 - 100	Intensity Red of Pixel 6 (0% --> 100%)
22	0 - 255	0 - 100	Intensity Green of Pixel 6 (0% --> 100%)
23	0 - 255	0 - 100	Intensity Blue of Pixel 6 (0% --> 100%)
24	0 - 255	0 - 100	Intensity Emulated White of Pixel 6 (0% --> 100%)
25	0 - 255	0 - 100	Intensity Red of Pixel 7 (0% --> 100%)
26	0 - 255	0 - 100	Intensity Green of Pixel 7 (0% --> 100%)
27	0 - 255	0 - 100	Intensity Blue of Pixel 7 (0% --> 100%)
28	0 - 255	0 - 100	Intensity Emulated White of Pixel 7 (0% --> 100%)
29	0 - 255	0 - 100	Intensity Red of Pixel 8 (0% --> 100%)
30	0 - 255	0 - 100	Intensity Green of Pixel 8 (0% --> 100%)
31	0 - 255	0 - 100	Intensity Blue of Pixel 8 (0% --> 100%)
32	0 - 255	0 - 100	Intensity Emulated White of Pixel 8 (0% --> 100%)
33	0 - 255	0 - 100	Intensity Red of Pixel 9 (0% --> 100%)
34	0 - 255	0 - 100	Intensity Green of Pixel 9 (0% --> 100%)
35	0 - 255	0 - 100	Intensity Blue of Pixel 9 (0% --> 100%)
36	0 - 255	0 - 100	Intensity Emulated White of Pixel 9 (0% --> 100%)
37	0 - 255	0 - 100	Intensity Red of Pixel 10 (0% --> 100%)
38	0 - 255	0 - 100	Intensity Green of Pixel 10 (0% --> 100%)
39	0 - 255	0 - 100	Intensity Blue of Pixel 10 (0% --> 100%)
40	0 - 255	0 - 100	Intensity Emulated White of Pixel 10 (0% --> 100%)
41	0 - 255	0 - 100	Intensity Red of Pixel 11 (0% --> 100%)



42	0 - 255	0 - 100	<b>Intensity Green of Pixel 11 (0% --&gt; 100%)</b>
43	0 - 255	0 - 100	<b>Intensity Blue of Pixel 11 (0% --&gt; 100%)</b>
44	0 - 255	0 - 100	<b>Intensity Emulated White of Pixel 11 (0% --&gt; 100%)</b>
45	0 - 255	0 - 100	<b>Intensity Red of Pixel 12 (0% --&gt; 100%)</b>
46	0 - 255	0 - 100	<b>Intensity Green of Pixel 12 (0% --&gt; 100%)</b>
47	0 - 255	0 - 100	<b>Intensity Blue of Pixel 12 (0% --&gt; 100%)</b>
48	0 - 255	0 - 100	<b>Intensity Emulated White of Pixel 12 (0% --&gt; 100%)</b>
49	0 - 255	0 - 100	<b>Intensity Red of Pixel 13 (0% --&gt; 100%)</b>
50	0 - 255	0 - 100	<b>Intensity Green of Pixel 13 (0% --&gt; 100%)</b>
51	0 - 255	0 - 100	<b>Intensity Blue of Pixel 13 (0% --&gt; 100%)</b>
52	0 - 255	0 - 100	<b>Intensity Emulated White of Pixel 13 (0% --&gt; 100%)</b>
53	0 - 255	0 - 100	<b>Intensity Red of Pixel 14 (0% --&gt; 100%)</b>
54	0 - 255	0 - 100	<b>Intensity Green of Pixel 14 (0% --&gt; 100%)</b>
55	0 - 255	0 - 100	<b>Intensity Blue of Pixel 14 (0% --&gt; 100%)</b>
56	0 - 255	0 - 100	<b>Intensity Emulated White of Pixel 14 (0% --&gt; 100%)</b>
57	0 - 255	0 - 100	<b>Intensity Red of Pixel 15 (0% --&gt; 100%)</b>
58	0 - 255	0 - 100	<b>Intensity Green of Pixel 15 (0% --&gt; 100%)</b>
59	0 - 255	0 - 100	<b>Intensity Blue of Pixel 15 (0% --&gt; 100%)</b>
60	0 - 255	0 - 100	<b>Intensity Emulated White of Pixel 15 (0% --&gt; 100%)</b>
61	0 - 255	0 - 100	<b>Intensity Red of Pixel 16 (0% --&gt; 100%)</b>
62	0 - 255	0 - 100	<b>Intensity Green of Pixel 16 (0% --&gt; 100%)</b>
63	0 - 255	0 - 100	<b>Intensity Blue of Pixel 16 (0% --&gt; 100%)</b>
64	0 - 255	0 - 100	<b>Intensity Emulated White of Pixel 16 (0% --&gt; 100%)</b>
65	0 - 3 4 5 6 7 - 255	0 - 1.2 1.6 2.0 2.4 2.7 - 100	<b>Strobe for all Pixels</b> Off Random Fast Random Medium Random Slow Variable Strobe (0.4Hz --> 25Hz)

## 52: RGBAW RGBAW (PIXEL = 16; STROBE = SINGLE)

CHANNEL	VALUE	PERCENTAGE	FUNCTION
1	0 - 255	0 - 100	Intensity Red of Pixel 1 (0% --> 100%)
2	0 - 255	0 - 100	Intensity Green of Pixel 1 (0% --> 100%)
3	0 - 255	0 - 100	Intensity Blue of Pixel 1 (0% --> 100%)
4	0 - 255	0 - 100	Intensity Amber of Pixel 1 (0% --> 100%)
5	0 - 255	0 - 100	Intensity Emulated White of Pixel 1 (0% --> 100%)
6	0 - 255	0 - 100	Intensity Red of Pixel 2 (0% --> 100%)
7	0 - 255	0 - 100	Intensity Green of Pixel 2 (0% --> 100%)
8	0 - 255	0 - 100	Intensity Blue of Pixel 2 (0% --> 100%)
9	0 - 255	0 - 100	Intensity Amber of Pixel 2 (0% --> 100%)
10	0 - 255	0 - 100	Intensity Emulated White of Pixel 2 (0% --> 100%)
11	0 - 255	0 - 100	Intensity Red of Pixel 3 (0% --> 100%)
12	0 - 255	0 - 100	Intensity Green of Pixel 3 (0% --> 100%)
13	0 - 255	0 - 100	Intensity Blue of Pixel 3 (0% --> 100%)
14	0 - 255	0 - 100	Intensity Amber of Pixel 3 (0% --> 100%)
15	0 - 255	0 - 100	Intensity Emulated White of Pixel 3 (0% --> 100%)
16	0 - 255	0 - 100	Intensity Red of Pixel 4 (0% --> 100%)
17	0 - 255	0 - 100	Intensity Green of Pixel 4 (0% --> 100%)
18	0 - 255	0 - 100	Intensity Blue of Pixel 4 (0% --> 100%)
19	0 - 255	0 - 100	Intensity Amber of Pixel 4 (0% --> 100%)
20	0 - 255	0 - 100	Intensity Emulated White of Pixel 4 (0% --> 100%)
21	0 - 255	0 - 100	Intensity Red of Pixel 5 (0% --> 100%)
22	0 - 255	0 - 100	Intensity Green of Pixel 5 (0% --> 100%)
23	0 - 255	0 - 100	Intensity Blue of Pixel 5 (0% --> 100%)
24	0 - 255	0 - 100	Intensity Amber of Pixel 5 (0% --> 100%)
25	0 - 255	0 - 100	Intensity Emulated White of Pixel 5 (0% --> 100%)
26	0 - 255	0 - 100	Intensity Red of Pixel 6 (0% --> 100%)
27	0 - 255	0 - 100	Intensity Green of Pixel 6 (0% --> 100%)
28	0 - 255	0 - 100	Intensity Blue of Pixel 6 (0% --> 100%)
29	0 - 255	0 - 100	Intensity Amber of Pixel 6 (0% --> 100%)
30	0 - 255	0 - 100	Intensity Emulated White of Pixel 6 (0% --> 100%)
31	0 - 255	0 - 100	Intensity Red of Pixel 7 (0% --> 100%)
32	0 - 255	0 - 100	Intensity Green of Pixel 7 (0% --> 100%)
33	0 - 255	0 - 100	Intensity Blue of Pixel 7 (0% --> 100%)
34	0 - 255	0 - 100	Intensity Amber of Pixel 7 (0% --> 100%)
35	0 - 255	0 - 100	Intensity Emulated White of Pixel 7 (0% --> 100%)
36	0 - 255	0 - 100	Intensity Red of Pixel 8 (0% --> 100%)
37	0 - 255	0 - 100	Intensity Green of Pixel 8 (0% --> 100%)
38	0 - 255	0 - 100	Intensity Blue of Pixel 8 (0% --> 100%)
39	0 - 255	0 - 100	Intensity Amber of Pixel 8 (0% --> 100%)
40	0 - 255	0 - 100	Intensity Emulated White of Pixel 8 (0% --> 100%)
41	0 - 255	0 - 100	Intensity Red of Pixel 9 (0% --> 100%)
42	0 - 255	0 - 100	Intensity Green of Pixel 9 (0% --> 100%)



43	0 - 255	0 - 100	<b>Intensity Blue of Pixel 9 (0% --&gt; 100%)</b>
44	0 - 255	0 - 100	<b>Intensity Amber of Pixel 9 (0% --&gt; 100%)</b>
45	0 - 255	0 - 100	<b>Intensity Emulated White of Pixel 9 (0% --&gt; 100%)</b>
46	0 - 255	0 - 100	<b>Intensity Red of Pixel 10 (0% --&gt; 100%)</b>
47	0 - 255	0 - 100	<b>Intensity Green of Pixel 10 (0% --&gt; 100%)</b>
48	0 - 255	0 - 100	<b>Intensity Blue of Pixel 10 (0% --&gt; 100%)</b>
49	0 - 255	0 - 100	<b>Intensity Amber of Pixel 10 (0% --&gt; 100%)</b>
50	0 - 255	0 - 100	<b>Intensity Emulated White of Pixel 10 (0% --&gt; 100%)</b>
51	0 - 255	0 - 100	<b>Intensity Red of Pixel 11 (0% --&gt; 100%)</b>
52	0 - 255	0 - 100	<b>Intensity Green of Pixel 11 (0% --&gt; 100%)</b>
53	0 - 255	0 - 100	<b>Intensity Blue of Pixel 11 (0% --&gt; 100%)</b>
54	0 - 255	0 - 100	<b>Intensity Amber of Pixel 11 (0% --&gt; 100%)</b>
55	0 - 255	0 - 100	<b>Intensity Emulated White of Pixel 11 (0% --&gt; 100%)</b>
56	0 - 255	0 - 100	<b>Intensity Red of Pixel 12 (0% --&gt; 100%)</b>
57	0 - 255	0 - 100	<b>Intensity Green of Pixel 12 (0% --&gt; 100%)</b>
58	0 - 255	0 - 100	<b>Intensity Blue of Pixel 12 (0% --&gt; 100%)</b>
59	0 - 255	0 - 100	<b>Intensity Amber of Pixel 12 (0% --&gt; 100%)</b>
60	0 - 255	0 - 100	<b>Intensity Emulated White of Pixel 12 (0% --&gt; 100%)</b>
61	0 - 255	0 - 100	<b>Intensity Red of Pixel 13 (0% --&gt; 100%)</b>
62	0 - 255	0 - 100	<b>Intensity Green of Pixel 13 (0% --&gt; 100%)</b>
63	0 - 255	0 - 100	<b>Intensity Blue of Pixel 13 (0% --&gt; 100%)</b>
64	0 - 255	0 - 100	<b>Intensity Amber of Pixel 13 (0% --&gt; 100%)</b>
65	0 - 255	0 - 100	<b>Intensity Emulated White of Pixel 13 (0% --&gt; 100%)</b>
66	0 - 255	0 - 100	<b>Intensity Red of Pixel 14 (0% --&gt; 100%)</b>
67	0 - 255	0 - 100	<b>Intensity Green of Pixel 14 (0% --&gt; 100%)</b>
68	0 - 255	0 - 100	<b>Intensity Blue of Pixel 14 (0% --&gt; 100%)</b>
69	0 - 255	0 - 100	<b>Intensity Amber of Pixel 14 (0% --&gt; 100%)</b>
70	0 - 255	0 - 100	<b>Intensity Emulated White of Pixel 14 (0% --&gt; 100%)</b>
71	0 - 255	0 - 100	<b>Intensity Red of Pixel 15 (0% --&gt; 100%)</b>
72	0 - 255	0 - 100	<b>Intensity Green of Pixel 15 (0% --&gt; 100%)</b>
73	0 - 255	0 - 100	<b>Intensity Blue of Pixel 15 (0% --&gt; 100%)</b>
74	0 - 255	0 - 100	<b>Intensity Amber of Pixel 15 (0% --&gt; 100%)</b>
75	0 - 255	0 - 100	<b>Intensity Emulated White of Pixel 15 (0% --&gt; 100%)</b>
76	0 - 255	0 - 100	<b>Intensity Red of Pixel 16 (0% --&gt; 100%)</b>
77	0 - 255	0 - 100	<b>Intensity Green of Pixel 16 (0% --&gt; 100%)</b>
78	0 - 255	0 - 100	<b>Intensity Blue of Pixel 16 (0% --&gt; 100%)</b>
79	0 - 255	0 - 100	<b>Intensity Amber of Pixel 16 (0% --&gt; 100%)</b>
80	0 - 255	0 - 100	<b>Intensity Emulated White of Pixel 16 (0% --&gt; 100%)</b>
81	0 - 3 4 5 6 7 - 255	0 - 1.2 1.6 2.0 2.4 2.7 - 100	<b>Strobe for all Pixels</b> Off Random Fast Random Medium Random Slow Variable Strobe (0.4Hz --> 25Hz)

### 53: DIM RGB DIM RGB .. S (PIXEL = 16; STROBE = SINGLE)

CHANNEL	VALUE	PERCENTAGE	FUNCTION
1	0..255	0 - 100	Dimmer of Pixel 1 (closed --> open)
2	0 - 255	0 - 100	Intensity Red of Pixel 1 (0% --> 100%)
3	0 - 255	0 - 100	Intensity Green of Pixel 1 (0% --> 100%)
4	0 - 255	0 - 100	Intensity Blue of Pixel 1 (0% --> 100%)
5	0 - 255	0 - 100	Dimmer of Pixel 2 (closed --> open)
6	0 - 255	0 - 100	Intensity Red of Pixel 2 (0% --> 100%)
7	0 - 255	0 - 100	Intensity Green of Pixel 2 (0% --> 100%)
8	0 - 255	0 - 100	Intensity Blue of Pixel 2 (0% --> 100%)
9	0 - 255	0 - 100	Dimmer of Pixel 3 (closed --> open)
10	0 - 255	0 - 100	Intensity Red of Pixel 3 (0% --> 100%)
11	0 - 255	0 - 100	Intensity Green of Pixel 3 (0% --> 100%)
12	0 - 255	0 - 100	Intensity Blue of Pixel 3 (0% --> 100%)
13	0 - 255	0 - 100	Dimmer of Pixel 4 (closed --> open)
14	0 - 255	0 - 100	Intensity Red of Pixel 4 (0% --> 100%)
15	0 - 255	0 - 100	Intensity Green of Pixel 4 (0% --> 100%)
16	0 - 255	0 - 100	Intensity Blue of Pixel 4 (0% --> 100%)
17	0 - 255	0 - 100	Dimmer of Pixel 5 (closed --> open)
18	0 - 255	0 - 100	Intensity Red of Pixel 5 (0% --> 100%)
19	0 - 255	0 - 100	Intensity Green of Pixel 5 (0% --> 100%)
20	0 - 255	0 - 100	Intensity Blue of Pixel 5 (0% --> 100%)
21	0 - 255	0 - 100	Dimmer of Pixel 6 (closed --> open)
22	0 - 255	0 - 100	Intensity Red of Pixel 6 (0% --> 100%)
23	0 - 255	0 - 100	Intensity Green of Pixel 6 (0% --> 100%)
24	0 - 255	0 - 100	Intensity Blue of Pixel 6 (0% --> 100%)
25	0 - 255	0 - 100	Dimmer of Pixel 7 (closed --> open)
26	0 - 255	0 - 100	Intensity Red of Pixel 7 (0% --> 100%)
27	0 - 255	0 - 100	Intensity Green of Pixel 7 (0% --> 100%)
28	0 - 255	0 - 100	Intensity Blue of Pixel 7 (0% --> 100%)
29	0 - 255	0 - 100	Dimmer of Pixel 8 (closed --> open)
30	0 - 255	0 - 100	Intensity Red of Pixel 8 (0% --> 100%)
31	0 - 255	0 - 100	Intensity Green of Pixel 8 (0% --> 100%)
32	0 - 255	0 - 100	Intensity Blue of Pixel 8 (0% --> 100%)
33	0 - 255	0 - 100	Dimmer of Pixel 9 (closed --> open)
34	0 - 255	0 - 100	Intensity Red of Pixel 9 (0% --> 100%)
35	0 - 255	0 - 100	Intensity Green of Pixel 9 (0% --> 100%)
36	0 - 255	0 - 100	Intensity Blue of Pixel 9 (0% --> 100%)
37	0 - 255	0 - 100	Dimmer of Pixel 10 (closed --> open)
38	0 - 255	0 - 100	Intensity Red of Pixel 10 (0% --> 100%)
39	0 - 255	0 - 100	Intensity Green of Pixel 10 (0% --> 100%)
40	0 - 255	0 - 100	Intensity Blue of Pixel 10 (0% --> 100%)
41	0 - 255	0 - 100	Dimmer of Pixel 11 (closed --> open)



42	0 - 255	0 - 100	<b>Intensity Red of Pixel 11 (0% --&gt; 100%)</b>
43	0 - 255	0 - 100	<b>Intensity Green of Pixel 11 (0% --&gt; 100%)</b>
44	0 - 255	0 - 100	<b>Intensity Blue of Pixel 11 (0% --&gt; 100%)</b>
45	0 - 255	0 - 100	<b>Dimmer of Pixel 12 (closed --&gt; open)</b>
46	0 - 255	0 - 100	<b>Intensity Red of Pixel 12 (0% --&gt; 100%)</b>
47	0 - 255	0 - 100	<b>Intensity Green of Pixel 12 (0% --&gt; 100%)</b>
48	0 - 255	0 - 100	<b>Intensity Blue of Pixel 12 (0% --&gt; 100%)</b>
49	0 - 255	0 - 100	<b>Dimmer of Pixel 13 (closed --&gt; open)</b>
50	0 - 255	0 - 100	<b>Intensity Red of Pixel 13 (0% --&gt; 100%)</b>
51	0 - 255	0 - 100	<b>Intensity Green of Pixel 13 (0% --&gt; 100%)</b>
52	0 - 255	0 - 100	<b>Intensity Blue of Pixel 13 (0% --&gt; 100%)</b>
53	0 - 255	0 - 100	<b>Dimmer of Pixel 14 (closed --&gt; open)</b>
54	0 - 255	0 - 100	<b>Intensity Red of Pixel 14 (0% --&gt; 100%)</b>
55	0 - 255	0 - 100	<b>Intensity Green of Pixel 14 (0% --&gt; 100%)</b>
56	0 - 255	0 - 100	<b>Intensity Blue of Pixel 14 (0% --&gt; 100%)</b>
57	0 - 255	0 - 100	<b>Dimmer of Pixel 15 (closed --&gt; open)</b>
58	0 - 255	0 - 100	<b>Intensity Red of Pixel 15 (0% --&gt; 100%)</b>
59	0 - 255	0 - 100	<b>Intensity Green of Pixel 15 (0% --&gt; 100%)</b>
60	0 - 255	0 - 100	<b>Intensity Blue of Pixel 15 (0% --&gt; 100%)</b>
61	0 - 255	0 - 100	<b>Dimmer of Pixel 16 (closed --&gt; open)</b>
62	0 - 255	0 - 100	<b>Intensity Red of Pixel 16 (0% --&gt; 100%)</b>
63	0 - 255	0 - 100	<b>Intensity Green of Pixel 16 (0% --&gt; 100%)</b>
64	0 - 255	0 - 100	<b>Intensity Blue of Pixel 16 (0% --&gt; 100%)</b>
65	0 - 3 4 5 6 7 - 255	0 - 1.2 1.6 2.0 2.4 2.7 - 100	<b>Strobe for all Pixels</b> Off Random Fast Random Medium Random Slow Variable Strobe (0.4Hz --> 25Hz)

**54: DIM RGBW DIM RGBW .. S (PIXEL = 16; STROBE = SINGLE)**

CHANNEL	VALUE	PERCENTAGE	FUNCTION
1	0 - 255	0 - 100	Dimmer of Pixel 1 (closed --> open)
2	0 - 255	0 - 100	Intensity Red of Pixel 1 (0% --> 100%)
3	0 - 255	0 - 100	Intensity Green of Pixel 1 (0% --> 100%)
4	0 - 255	0 - 100	Intensity Blue of Pixel 1 (0% --> 100%)
5	0 - 255	0 - 100	Intensity Emulated White of Pixel 1 (0% --> 100%)
6	0 - 255	0 - 100	Dimmer of Pixel 2 (closed --> open)
7	0 - 255	0 - 100	Intensity Red of Pixel 2 (0% --> 100%)
8	0 - 255	0 - 100	Intensity Green of Pixel 2 (0% --> 100%)
9	0 - 255	0 - 100	Intensity Blue of Pixel 2 (0% --> 100%)
10	0 - 255	0 - 100	Intensity Emulated White of Pixel 2 (0% --> 100%)
11	0 - 255	0 - 100	Dimmer of Pixel 3 (closed --> open)
12	0 - 255	0 - 100	Intensity Red of Pixel 3 (0% --> 100%)
13	0 - 255	0 - 100	Intensity Green of Pixel 3 (0% --> 100%)
14	0 - 255	0 - 100	Intensity Blue of Pixel 3 (0% --> 100%)
15	0 - 255	0 - 100	Intensity Emulated White of Pixel 3 (0% --> 100%)
16	0 - 255	0 - 100	Dimmer of Pixel 4 (closed --> open)
17	0 - 255	0 - 100	Intensity Red of Pixel 4 (0% --> 100%)
18	0 - 255	0 - 100	Intensity Green of Pixel 4 (0% --> 100%)
19	0 - 255	0 - 100	Intensity Blue of Pixel 4 (0% --> 100%)
20	0 - 255	0 - 100	Intensity Emulated White of Pixel 4 (0% --> 100%)
21	0 - 255	0 - 100	Dimmer of Pixel 5 (closed --> open)
22	0 - 255	0 - 100	Intensity Red of Pixel 5 (0% --> 100%)
23	0 - 255	0 - 100	Intensity Green of Pixel 5 (0% --> 100%)
24	0 - 255	0 - 100	Intensity Blue of Pixel 5 (0% --> 100%)
25	0 - 255	0 - 100	Intensity Emulated White of Pixel 5 (0% --> 100%)
26	0 - 255	0 - 100	Dimmer of Pixel 6 (closed --> open)
27	0 - 255	0 - 100	Intensity Red of Pixel 6 (0% --> 100%)
28	0 - 255	0 - 100	Intensity Green of Pixel 6 (0% --> 100%)
29	0 - 255	0 - 100	Intensity Blue of Pixel 6 (0% --> 100%)
30	0 - 255	0 - 100	Intensity Emulated White of Pixel 6 (0% --> 100%)
31	0 - 255	0 - 100	Dimmer of Pixel 7 (closed --> open)
32	0 - 255	0 - 100	Intensity Red of Pixel 7 (0% --> 100%)
33	0 - 255	0 - 100	Intensity Green of Pixel 7 (0% --> 100%)
34	0 - 255	0 - 100	Intensity Blue of Pixel 7 (0% --> 100%)
35	0 - 255	0 - 100	Intensity Emulated White of Pixel 7 (0% --> 100%)
36	0 - 255	0 - 100	Dimmer of Pixel 8 (closed --> open)
37	0 - 255	0 - 100	Intensity Red of Pixel 8 (0% --> 100%)
38	0 - 255	0 - 100	Intensity Green of Pixel 8 (0% --> 100%)
39	0 - 255	0 - 100	Intensity Blue of Pixel 8 (0% --> 100%)
40	0 - 255	0 - 100	Intensity Emulated White of Pixel 8 (0% --> 100%)
41	0 - 255	0 - 100	Dimmer of Pixel 9 (closed --> open)
42	0 - 255	0 - 100	Intensity Red of Pixel 9 (0% --> 100%)



43	0 - 255	0 - 100	<b>Intensity Green of Pixel 9 (0% --&gt; 100%)</b>
44	0 - 255	0 - 100	<b>Intensity Blue of Pixel 9 (0% --&gt; 100%)</b>
45	0 - 255	0 - 100	<b>Intensity Emulated White of Pixel 9 (0% --&gt; 100%)</b>
46	0 - 255	0 - 100	<b>Dimmer of Pixel 10 (closed --&gt; open)</b>
47	0 - 255	0 - 100	<b>Intensity Red of Pixel 10 (0% --&gt; 100%)</b>
48	0 - 255	0 - 100	<b>Intensity Green of Pixel 10 (0% --&gt; 100%)</b>
49	0 - 255	0 - 100	<b>Intensity Blue of Pixel 10 (0% --&gt; 100%)</b>
50	0 - 255	0 - 100	<b>Intensity Emulated White of Pixel 10 (0% --&gt; 100%)</b>
51	0 - 255	0 - 100	<b>Dimmer of Pixel 11 (closed --&gt; open)</b>
52	0 - 255	0 - 100	<b>Intensity Red of Pixel 11 (0% --&gt; 100%)</b>
53	0 - 255	0 - 100	<b>Intensity Green of Pixel 11 (0% --&gt; 100%)</b>
54	0 - 255	0 - 100	<b>Intensity Blue of Pixel 11 (0% --&gt; 100%)</b>
55	0 - 255	0 - 100	<b>Intensity Emulated White of Pixel 11 (0% --&gt; 100%)</b>
56	0 - 255	0 - 100	<b>Dimmer of Pixel 12 (closed --&gt; open)</b>
57	0 - 255	0 - 100	<b>Intensity Red of Pixel 12 (0% --&gt; 100%)</b>
58	0 - 255	0 - 100	<b>Intensity Green of Pixel 12 (0% --&gt; 100%)</b>
59	0 - 255	0 - 100	<b>Intensity Blue of Pixel 12 (0% --&gt; 100%)</b>
60	0 - 255	0 - 100	<b>Intensity Emulated White of Pixel 12 (0% --&gt; 100%)</b>
61	0 - 255	0 - 100	<b>Dimmer of Pixel 13 (closed --&gt; open)</b>
62	0 - 255	0 - 100	<b>Intensity Red of Pixel 13 (0% --&gt; 100%)</b>
63	0 - 255	0 - 100	<b>Intensity Green of Pixel 13 (0% --&gt; 100%)</b>
64	0 - 255	0 - 100	<b>Intensity Blue of Pixel 13 (0% --&gt; 100%)</b>
65	0 - 255	0 - 100	<b>Intensity Emulated White of Pixel 13 (0% --&gt; 100%)</b>
66	0 - 255	0 - 100	<b>Dimmer of Pixel 14 (closed --&gt; open)</b>
67	0 - 255	0 - 100	<b>Intensity Red of Pixel 14 (0% --&gt; 100%)</b>
68	0 - 255	0 - 100	<b>Intensity Green of Pixel 14 (0% --&gt; 100%)</b>
69	0 - 255	0 - 100	<b>Intensity Blue of Pixel 14 (0% --&gt; 100%)</b>
70	0 - 255	0 - 100	<b>Intensity Emulated White of Pixel 14 (0% --&gt; 100%)</b>
71	0 - 255	0 - 100	<b>Dimmer of Pixel 15 (closed --&gt; open)</b>
72	0 - 255	0 - 100	<b>Intensity Red of Pixel 15 (0% --&gt; 100%)</b>
73	0 - 255	0 - 100	<b>Intensity Green of Pixel 15 (0% --&gt; 100%)</b>
74	0 - 255	0 - 100	<b>Intensity Blue of Pixel 15 (0% --&gt; 100%)</b>
75	0 - 255	0 - 100	<b>Intensity Emulated White of Pixel 15 (0% --&gt; 100%)</b>
76	0 - 255	0 - 100	<b>Dimmer of Pixel 16 (closed --&gt; open)</b>
77	0 - 255	0 - 100	<b>Intensity Red of Pixel 16 (0% --&gt; 100%)</b>
78	0 - 255	0 - 100	<b>Intensity Green of Pixel 16 (0% --&gt; 100%)</b>
79	0 - 255	0 - 100	<b>Intensity Blue of Pixel 16 (0% --&gt; 100%)</b>
80	0 - 255	0 - 100	<b>Intensity Emulated White of Pixel 16 (0% --&gt; 100%)</b>
81	0 - 3 4 5 6 7 - 255	0 - 1.2 1.6 2.0 2.4 2.7 - 100	<b>Strobe for all Pixels</b> Off Random Fast Random Medium Random Slow Variable Strobe (0.4Hz --> 25Hz)

### 55: DIM RGBAW DIM RGBAW .. S (PIXEL = 16; STROBE = SINGLE)

CHANNEL	VALUE	PERCENTAGE	FUNCTION
1	0 - 255	0 - 100	Dimmer of Pixel 1 (closed --> open)
2	0 - 255	0 - 100	Intensity Red of Pixel 1 (0% --> 100%)
3	0 - 255	0 - 100	Intensity Green of Pixel 1 (0% --> 100%)
4	0 - 255	0 - 100	Intensity Blue of Pixel 1 (0% --> 100%)
5	0 - 255	0 - 100	Intensity Amber of Pixel 1 (0% --> 100%)
6	0 - 255	0 - 100	Intensity Emulated White of Pixel 1 (0% --> 100%)
7	0 - 255	0 - 100	Dimmer of Pixel 2 (closed --> open)
8	0 - 255	0 - 100	Intensity Red of Pixel 2 (0% --> 100%)
9	0 - 255	0 - 100	Intensity Green of Pixel 2 (0% --> 100%)
10	0 - 255	0 - 100	Intensity Blue of Pixel 2 (0% --> 100%)
11	0 - 255	0 - 100	Intensity Amber of Pixel 2 (0% --> 100%)
12	0 - 255	0 - 100	Intensity Emulated White of Pixel 2 (0% --> 100%)
13	0 - 255	0 - 100	Dimmer of Pixel 3 (closed --> open)
14	0 - 255	0 - 100	Intensity Red of Pixel 3 (0% --> 100%)
15	0 - 255	0 - 100	Intensity Green of Pixel 3 (0% --> 100%)
16	0 - 255	0 - 100	Intensity Blue of Pixel 3 (0% --> 100%)
17	0 - 255	0 - 100	Intensity Amber of Pixel 3 (0% --> 100%)
18	0 - 255	0 - 100	Intensity Emulated White of Pixel 3 (0% --> 100%)
19	0 - 255	0 - 100	Dimmer of Pixel 4 (closed --> open)
20	0 - 255	0 - 100	Intensity Red of Pixel 4 (0% --> 100%)
21	0 - 255	0 - 100	Intensity Green of Pixel 4 (0% --> 100%)
22	0 - 255	0 - 100	Intensity Blue of Pixel 4 (0% --> 100%)
23	0 - 255	0 - 100	Intensity Amber of Pixel 4 (0% --> 100%)
24	0 - 255	0 - 100	Intensity Emulated White of Pixel 4 (0% --> 100%)
25	0 - 255	0 - 100	Dimmer of Pixel 5 (closed --> open)
26	0 - 255	0 - 100	Intensity Red of Pixel 5 (0% --> 100%)
27	0 - 255	0 - 100	Intensity Green of Pixel 5 (0% --> 100%)
28	0 - 255	0 - 100	Intensity Blue of Pixel 5 (0% --> 100%)
29	0 - 255	0 - 100	Intensity Amber of Pixel 5 (0% --> 100%)
30	0 - 255	0 - 100	Intensity Emulated White of Pixel 5 (0% --> 100%)
31	0 - 255	0 - 100	Dimmer of Pixel 6 (closed --> open)
32	0 - 255	0 - 100	Intensity Red of Pixel 6 (0% --> 100%)
33	0 - 255	0 - 100	Intensity Green of Pixel 6 (0% --> 100%)
34	0 - 255	0 - 100	Intensity Blue of Pixel 6 (0% --> 100%)
35	0 - 255	0 - 100	Intensity Amber of Pixel 6 (0% --> 100%)
36	0 - 255	0 - 100	Intensity Emulated White of Pixel 6 (0% --> 100%)
37	0 - 255	0 - 100	Dimmer of Pixel 7 (closed --> open)
38	0 - 255	0 - 100	Intensity Red of Pixel 7 (0% --> 100%)
39	0 - 255	0 - 100	Intensity Green of Pixel 7 (0% --> 100%)
40	0 - 255	0 - 100	Intensity Blue of Pixel 7 (0% --> 100%)
41	0 - 255	0 - 100	Intensity Amber of Pixel 7 (0% --> 100%)



42	0 - 255	0 - 100	<b>Intensity Emulated White of Pixel 7 (0% --&gt; 100%)</b>
43	0 - 255	0 - 100	<b>Dimmer of Pixel 8 (closed --&gt; open)</b>
44	0 - 255	0 - 100	<b>Intensity Red of Pixel 8 (0% --&gt; 100%)</b>
45	0 - 255	0 - 100	<b>Intensity Green of Pixel 8 (0% --&gt; 100%)</b>
46	0 - 255	0 - 100	<b>Intensity Blue of Pixel 8 (0% --&gt; 100%)</b>
47	0 - 255	0 - 100	<b>Intensity Amber of Pixel 8 (0% --&gt; 100%)</b>
48	0 - 255	0 - 100	<b>Intensity Emulated White of Pixel 8 (0% --&gt; 100%)</b>
49	0 - 255	0 - 100	<b>Dimmer of Pixel 9 (closed --&gt; open)</b>
50	0 - 255	0 - 100	<b>Intensity Red of Pixel 9 (0% --&gt; 100%)</b>
51	0 - 255	0 - 100	<b>Intensity Green of Pixel 9 (0% --&gt; 100%)</b>
52	0 - 255	0 - 100	<b>Intensity Blue of Pixel 9 (0% --&gt; 100%)</b>
53	0 - 255	0 - 100	<b>Intensity Amber of Pixel 9 (0% --&gt; 100%)</b>
54	0 - 255	0 - 100	<b>Intensity Emulated White of Pixel 9 (0% --&gt; 100%)</b>
55	0 - 255	0 - 100	<b>Dimmer of Pixel 10 (closed --&gt; open)</b>
56	0 - 255	0 - 100	<b>Intensity Red of Pixel 10 (0% --&gt; 100%)</b>
57	0 - 255	0 - 100	<b>Intensity Green of Pixel 10 (0% --&gt; 100%)</b>
58	0 - 255	0 - 100	<b>Intensity Blue of Pixel 10 (0% --&gt; 100%)</b>
59	0 - 255	0 - 100	<b>Intensity Amber of Pixel 10 (0% --&gt; 100%)</b>
60	0 - 255	0 - 100	<b>Intensity Emulated White of Pixel 10 (0% --&gt; 100%)</b>
61	0 - 255	0 - 100	<b>Dimmer of Pixel 11 (closed --&gt; open)</b>
62	0 - 255	0 - 100	<b>Intensity Red of Pixel 11 (0% --&gt; 100%)</b>
63	0 - 255	0 - 100	<b>Intensity Green of Pixel 11 (0% --&gt; 100%)</b>
64	0 - 255	0 - 100	<b>Intensity Blue of Pixel 11 (0% --&gt; 100%)</b>
65	0 - 255	0 - 100	<b>Intensity Amber of Pixel 11 (0% --&gt; 100%)</b>
66	0 - 255	0 - 100	<b>Intensity Emulated White of Pixel 11 (0% --&gt; 100%)</b>
67	0 - 255	0 - 100	<b>Dimmer of Pixel 12 (closed --&gt; open)</b>
68	0 - 255	0 - 100	<b>Intensity Red of Pixel 12 (0% --&gt; 100%)</b>
69	0 - 255	0 - 100	<b>Intensity Green of Pixel 12 (0% --&gt; 100%)</b>
70	0 - 255	0 - 100	<b>Intensity Blue of Pixel 12 (0% --&gt; 100%)</b>
71	0 - 255	0 - 100	<b>Intensity Amber of Pixel 12 (0% --&gt; 100%)</b>
72	0 - 255	0 - 100	<b>Intensity Emulated White of Pixel 12 (0% --&gt; 100%)</b>
73	0 - 255	0 - 100	<b>Dimmer of Pixel 13 (closed --&gt; open)</b>
74	0 - 255	0 - 100	<b>Intensity Red of Pixel 13 (0% --&gt; 100%)</b>
75	0 - 255	0 - 100	<b>Intensity Green of Pixel 13 (0% --&gt; 100%)</b>
76	0 - 255	0 - 100	<b>Intensity Blue of Pixel 13 (0% --&gt; 100%)</b>
77	0 - 255	0 - 100	<b>Intensity Amber of Pixel 13 (0% --&gt; 100%)</b>
78	0 - 255	0 - 100	<b>Intensity Emulated White of Pixel 13 (0% --&gt; 100%)</b>
79	0 - 255	0 - 100	<b>Dimmer of Pixel 14 (closed --&gt; open)</b>
80	0 - 255	0 - 100	<b>Intensity Red of Pixel 14 (0% --&gt; 100%)</b>
81	0 - 255	0 - 100	<b>Intensity Green of Pixel 14 (0% --&gt; 100%)</b>
82	0 - 255	0 - 100	<b>Intensity Blue of Pixel 14 (0% --&gt; 100%)</b>
83	0 - 255	0 - 100	<b>Intensity Amber of Pixel 14 (0% --&gt; 100%)</b>
84	0 - 255	0 - 100	<b>Intensity Emulated White of Pixel 14 (0% --&gt; 100%)</b>
85	0 - 255	0 - 100	<b>Dimmer of Pixel 15 (closed --&gt; open)</b>



86	0 - 255	0 - 100	<b>Intensity Red of Pixel 15 (0% --&gt; 100%)</b>
87	0 - 255	0 - 100	<b>Intensity Green of Pixel 15 (0% --&gt; 100%)</b>
88	0 - 255	0 - 100	<b>Intensity Blue of Pixel 15 (0% --&gt; 100%)</b>
89	0 - 255	0 - 100	<b>Intensity Amber of Pixel 15 (0% --&gt; 100%)</b>
90	0 - 255	0 - 100	<b>Intensity Emulated White of Pixel 15 (0% --&gt; 100%)</b>
91	0 - 255	0 - 100	<b>Dimmer of Pixel 16 (closed --&gt; open)</b>
92	0 - 255	0 - 100	<b>Intensity Red of Pixel 16 (0% --&gt; 100%)</b>
93	0 - 255	0 - 100	<b>Intensity Green of Pixel 16 (0% --&gt; 100%)</b>
94	0 - 255	0 - 100	<b>Intensity Blue of Pixel 16 (0% --&gt; 100%)</b>
95	0 - 255	0 - 100	<b>Intensity Amber of Pixel 16 (0% --&gt; 100%)</b>
96	0 - 255	0 - 100	<b>Intensity Emulated White of Pixel 16 (0% --&gt; 100%)</b>
97	0 - 3 4 5 6 7 - 255	0 - 1.2 1.6 2.0 2.4 2.7 - 100	<b>Strobe for all Pixels</b> Off Random Fast Random Medium Random Slow Variable Strobe (0.4Hz --> 25Hz)

## 56: RGB CCT DIM IND S (PIXEL = 16; STROBE = SINGLE)

CHANNEL	VALUE	PERCENTAGE	FUNCTION
1	0 - 255	0 - 100	<b>Intensity Red of Pixel 1</b> (0% --> 100%)
2	0 - 255	0 - 100	<b>Intensity Green of Pixel 1</b> (0% --> 100%)
3	0 - 255	0 - 100	<b>Intensity Blue of Pixel 1</b> (0% --> 100%)
4	0 - 4 4 - 255	0 - 1.5 1.6-100	<b>Color Temperature (CCT) of Pixel 1</b> No effect Display color temperature Formula: $CCT = 2000 + 20 * DMX-Value$ Example: 50 --> 3000K 100 --> 4000K 150 --> 5000K <i>*CCT overwrites the RGB setting</i>
5	0..255	0 - 100	<b>Dimmer of Pixel 1</b> (closed --> open)
6	0..1 2..255	0 - 0.4 0.8 - 100	<b>LEE Color Gel of Pixel 1</b> No effect Display LEE color gel (full list on page 171) <i>*LEE Color Gel overwrites both, RGB and CCT</i>
7	0 - 255	0 - 100	<b>Intensity Red of Pixel 2</b> (0% --> 100%)
8	0 - 255	0 - 100	<b>Intensity Green of Pixel 2</b> (0% --> 100%)
9	0 - 255	0 - 100	<b>Intensity Blue of Pixel 2</b> (0% --> 100%)
10	0 - 4 4 - 255	0 - 1.5 1.6-100	<b>Color Temperature (CCT) of Pixel 2</b> No effect Display color temperature Formula: $CCT = 2000 + 20 * DMX-Value$ Example: 50 --> 3000K 100 --> 4000K 150 --> 5000K <i>*CCT overwrites the RGB setting</i>
11	0..255	0 - 100	<b>Dimmer of Pixel 2</b> (closed --> open)
12	0..1 2..255	0 - 0.4 0.8 - 100	<b>LEE Color Gel of Pixel 2</b> No effect Display LEE color gel (full list on page 171) <i>*LEE Color Gel overwrites both, RGB and CCT</i>
13	0 - 255	0 - 100	<b>Intensity Red of Pixel 3</b> (0% --> 100%)
14	0 - 255	0 - 100	<b>Intensity Green of Pixel 3</b> (0% --> 100%)
15	0 - 255	0 - 100	<b>Intensity Blue of Pixel 3</b> (0% --> 100%)
16	0 - 4 4 - 255	0 - 1.5 1.6-100	<b>Color Temperature (CCT) of Pixel 3</b> No effect Display color temperature Formula: $CCT = 2000 + 20 * DMX-Value$ Example: 50 --> 3000K 100 --> 4000K 150 --> 5000K

			<i>*CCT overwrites the RGB setting</i>
17	0..255	0 - 100	<b>Dimmer of Pixel 3</b> (closed --> open)
18	0..1 2..255	0 - 0.4 0.8 - 100	<b>LEE Color Gel of Pixel 3</b> No effect Display LEE color gel (full list on page 171) <i>*LEE Color Gel overwrites both, RGB and CCT</i>
19	0 - 255	0 - 100	<b>Intensity Red of Pixel 4</b> (0% --> 100%)
20	0 - 255	0 - 100	<b>Intensity Green of Pixel 4</b> (0% --> 100%)
21	0 - 255	0 - 100	<b>Intensity Blue of Pixel 4</b> (0% --> 100%)
22	0 - 4 4 - 255	0 - 1.5 1.6-100	<b>Color Temperature (CCT) of Pixel 4</b> No effect Display color temperature Formula: $CCT = 2000 + 20 * DMX-Value$ Example:           50 --> 3000K 100 --> 4000K 150 --> 5000K <i>*CCT overwrites the RGB setting</i>
23	0..255	0 - 100	<b>Dimmer of Pixel 4</b> (closed --> open)
24	0..1 2..255	0 - 0.4 0.8 - 100	<b>LEE Color Gel of Pixel 4</b> No effect Display LEE color gel (full list on page 171) <i>*LEE Color Gel overwrites both, RGB and CCT</i>
25	0 - 255	0 - 100	<b>Intensity Red of Pixel 5</b> (0% --> 100%)
26	0 - 255	0 - 100	<b>Intensity Green of Pixel 5</b> (0% --> 100%)
27	0 - 255	0 - 100	<b>Intensity Blue of Pixel 5</b> (0% --> 100%)
28	0 - 4 4 - 255	0 - 1.5 1.6-100	<b>Color Temperature (CCT) of Pixel 5</b> No effect Display color temperature Formula: $CCT = 2000 + 20 * DMX-Value$ Example:           50 --> 3000K 100 --> 4000K 150 --> 5000K <i>*CCT overwrites the RGB setting</i>
29	0..255	0 - 100	<b>Dimmer of Pixel 5</b> (closed --> open)
30	0..1 2..255	0 - 0.4 0.8 - 100	<b>LEE Color Gel of Pixel 5</b> No effect Display LEE color gel (full list on page 171) <i>*LEE Color Gel overwrites both, RGB and CCT</i>
31	0 - 255	0 - 100	<b>Intensity Red of Pixel 6</b> (0% --> 100%)
32	0 - 255	0 - 100	<b>Intensity Green of Pixel 6</b> (0% --> 100%)
33	0 - 255	0 - 100	<b>Intensity Blue of Pixel 6</b> (0% --> 100%)
34	0 - 4 4 - 255	0 - 1.5 1.6-100	<b>Color Temperature (CCT) of Pixel 6</b> No effect Display color temperature Formula: $CCT = 2000 + 20 * DMX-Value$

			<p>Example: 50 --&gt; 3000K 100 --&gt; 4000K 150 --&gt; 5000K</p> <p><i>*CCT overwrites the RGB setting</i></p>
35	0..255	0 - 100	<b>Dimmer of Pixel 6</b> (closed --> open)
36	0..1 2..255	0 - 0.4 0.8 - 100	<p><b>LEE Color Gel of Pixel 6</b></p> <p>No effect</p> <p>Display LEE color gel (full list on page 171)</p> <p><i>*LEE Color Gel overwrites both, RGB and CCT</i></p>
37	0 - 255	0 - 100	<b>Intensity Red of Pixel 7</b> (0% --> 100%)
38	0 - 255	0 - 100	<b>Intensity Green of Pixel 7</b> (0% --> 100%)
39	0 - 255	0 - 100	<b>Intensity Blue of Pixel 7</b> (0% --> 100%)
40	0 - 4 4 - 255	0 - 1.5 1.6-100	<p><b>Color Temperature (CCT) of Pixel 7</b></p> <p>No effect</p> <p>Display color temperature</p> <p>Formula: <math>CCT = 2000 + 20 * DMX-Value</math></p> <p>Example: 50 --&gt; 3000K 100 --&gt; 4000K 150 --&gt; 5000K</p> <p><i>*CCT overwrites the RGB setting</i></p>
41	0..255	0 - 100	<b>Dimmer of Pixel 7</b> (closed --> open)
42	0..1 2..255	0 - 0.4 0.8 - 100	<p><b>LEE Color Gel of Pixel 7</b></p> <p>No effect</p> <p>Display LEE color gel (full list on page 171)</p> <p><i>*LEE Color Gel overwrites both, RGB and CCT</i></p>
43	0 - 255	0 - 100	<b>Intensity Red of Pixel 8</b> (0% --> 100%)
44	0 - 255	0 - 100	<b>Intensity Green of Pixel 8</b> (0% --> 100%)
45	0 - 255	0 - 100	<b>Intensity Blue of Pixel 8</b> (0% --> 100%)
46	0 - 4 4 - 255	0 - 1.5 1.6-100	<p><b>Color Temperature (CCT) of Pixel 8</b></p> <p>No effect</p> <p>Display color temperature</p> <p>Formula: <math>CCT = 2000 + 20 * DMX-Value</math></p> <p>Example: 50 --&gt; 3000K 100 --&gt; 4000K 150 --&gt; 5000K</p> <p><i>*CCT overwrites the RGB setting</i></p>
47	0..255	0 - 100	<b>Dimmer of Pixel 8</b> (closed --> open)
48	0..1 2..255	0 - 0.4 0.8 - 100	<p><b>LEE Color Gel of Pixel 8</b></p> <p>No effect</p> <p>Display LEE color gel (full list on page 171)</p> <p><i>*LEE Color Gel overwrites both, RGB and CCT</i></p>
49	0 - 255	0 - 100	<b>Intensity Red of Pixel 9</b> (0% --> 100%)
50	0 - 255	0 - 100	<b>Intensity Green of Pixel 9</b> (0% --> 100%)
51	0 - 255	0 - 100	<b>Intensity Blue of Pixel 9</b> (0% --> 100%)
52			<b>Color Temperature (CCT) of Pixel 9</b>

	0 - 4 4 - 255	0 - 1.5 1.6-100	No effect Display color temperature Formula: $CCT = 2000 + 20 * DMX-Value$ Example: 50 --> 3000K 100 --> 4000K 150 --> 5000K <i>*CCT overwrites the RGB setting</i>
53	0..255	0 - 100	<b>Dimmer of Pixel 9</b> (closed --> open)
54	0..1 2..255	0 - 0.4 0.8 - 100	<b>LEE Color Gel of Pixel 9</b> No effect Display LEE color gel (full list on page 171) <i>*LEE Color Gel overwrites both, RGB and CCT</i>
55	0 - 255	0 - 100	<b>Intensity Red of Pixel 10</b> (0% --> 100%)
56	0 - 255	0 - 100	<b>Intensity Green of Pixel 10</b> (0% --> 100%)
57	0 - 255	0 - 100	<b>Intensity Blue of Pixel 10</b> (0% --> 100%)
58	0 - 4 4 - 255	0 - 1.5 1.6-100	<b>Color Temperature (CCT) of Pixel 10</b> No effect Display color temperature Formula: $CCT = 2000 + 20 * DMX-Value$ Example: 50 --> 3000K 100 --> 4000K 150 --> 5000K <i>*CCT overwrites the RGB setting</i>
59	0..255	0 - 100	<b>Dimmer of Pixel 10</b> (closed --> open)
60	0..1 2..255	0 - 0.4 0.8 - 100	<b>LEE Color Gel of Pixel 10</b> No effect Display LEE color gel (full list on page 171) <i>*LEE Color Gel overwrites both, RGB and CCT</i>
61	0 - 255	0 - 100	<b>Intensity Red of Pixel 11</b> (0% --> 100%)
62	0 - 255	0 - 100	<b>Intensity Green of Pixel 11</b> (0% --> 100%)
63	0 - 255	0 - 100	<b>Intensity Blue of Pixel 11</b> (0% --> 100%)
64	0 - 4 4 - 255	0 - 1.5 1.6-100	<b>Color Temperature (CCT) of Pixel 11</b> No effect Display color temperature Formula: $CCT = 2000 + 20 * DMX-Value$ Example: 50 --> 3000K 100 --> 4000K 150 --> 5000K <i>*CCT overwrites the RGB setting</i>
65	0..255	0 - 100	<b>Dimmer of Pixel 11</b> (closed --> open)
66	0..1 2..255	0 - 0.4 0.8 - 100	<b>LEE Color Gel of Pixel 11</b> No effect Display LEE color gel (full list on page 171) <i>*LEE Color Gel overwrites both, RGB and CCT</i>
67	0 - 255	0 - 100	<b>Intensity Red of Pixel 12</b> (0% --> 100%)

68	0 - 255	0 - 100	<b>Intensity Green of Pixel 12 (0% --&gt; 100%)</b>
69	0 - 255	0 - 100	<b>Intensity Blue of Pixel 12 (0% --&gt; 100%)</b>
70	0 - 4 4 - 255	0 - 1.5 1.6-100	<b>Color Temperature (CCT) of Pixel 12</b> No effect Display color temperature Formula: CCT = 2000 + 20*DMX-Value Example: 50 --> 3000K 100 --> 4000K 150 --> 5000K <i>*CCT overwrites the RGB setting</i>
71	0..255	0 - 100	<b>Dimmer of Pixel 12 (closed --&gt; open)</b>
72	0..1 2..255	0 - 0.4 0.8 - 100	<b>LEE Color Gel of Pixel 12</b> No effect Display LEE color gel (full list on page 171) <i>*LEE Color Gel overwrites both, RGB and CCT</i>
73	0 - 255	0 - 100	<b>Intensity Red of Pixel 13 (0% --&gt; 100%)</b>
74	0 - 255	0 - 100	<b>Intensity Green of Pixel 13 (0% --&gt; 100%)</b>
75	0 - 255	0 - 100	<b>Intensity Blue of Pixel 13 (0% --&gt; 100%)</b>
76	0 - 4 4 - 255	0 - 1.5 1.6-100	<b>Color Temperature (CCT) of Pixel 13</b> No effect Display color temperature Formula: CCT = 2000 + 20*DMX-Value Example: 50 --> 3000K 100 --> 4000K 150 --> 5000K <i>*CCT overwrites the RGB setting</i>
77	0..255	0 - 100	<b>Dimmer of Pixel 13 (closed --&gt; open)</b>
78	0..1 2..255	0 - 0.4 0.8 - 100	<b>LEE Color Gel of Pixel 13</b> No effect Display LEE color gel (full list on page 171) <i>*LEE Color Gel overwrites both, RGB and CCT</i>
79	0 - 255	0 - 100	<b>Intensity Red of Pixel 14 (0% --&gt; 100%)</b>
80	0 - 255	0 - 100	<b>Intensity Green of Pixel 14 (0% --&gt; 100%)</b>
81	0 - 255	0 - 100	<b>Intensity Blue of Pixel 14 (0% --&gt; 100%)</b>
82	0 - 4 4 - 255	0 - 1.5 1.6-100	<b>Color Temperature (CCT) of Pixel 14</b> No effect Display color temperature Formula: CCT = 2000 + 20*DMX-Value Example: 50 --> 3000K 100 --> 4000K 150 --> 5000K <i>*CCT overwrites the RGB setting</i>
83	0..255	0 - 100	<b>Dimmer of Pixel 14 (closed --&gt; open)</b>
84	0..1	0 - 0.4	<b>LEE Color Gel of Pixel 14</b> No effect

	2..255	0.8 - 100	Display LEE color gel (full list on page 171) <i>*LEE Color Gel overwrites both, RGB and CCT</i>
85	0 - 255	0 - 100	<b>Intensity Red of Pixel 15</b> (0% --> 100%)
86	0 - 255	0 - 100	<b>Intensity Green of Pixel 15</b> (0% --> 100%)
87	0 - 255	0 - 100	<b>Intensity Blue of Pixel 15</b> (0% --> 100%)
88	0 - 4 4 - 255	0 - 1.5 1.6-100	<b>Color Temperature (CCT) of Pixel 15</b> No effect Display color temperature Formula: $CCT = 2000 + 20 * DMX\text{-Value}$ Example:           50 --> 3000K 100 --> 4000K 150 --> 5000K <i>*CCT overwrites the RGB setting</i>
89	0..255	0 - 100	<b>Dimmer of Pixel 15</b> (closed --> open)
90	0..1 2..255	0 - 0.4 0.8 - 100	<b>LEE Color Gel of Pixel 15</b> No effect Display LEE color gel (full list on page 171) <i>*LEE Color Gel overwrites both, RGB and CCT</i>
91	0 - 255	0 - 100	<b>Intensity Red of Pixel 16</b> (0% --> 100%)
92	0 - 255	0 - 100	<b>Intensity Green of Pixel 16</b> (0% --> 100%)
93	0 - 255	0 - 100	<b>Intensity Blue of Pixel 16</b> (0% --> 100%)
94	0 - 4 4 - 255	0 - 1.5 1.6-100	<b>Color Temperature (CCT) of Pixel 16</b> No effect Display color temperature Formula: $CCT = 2000 + 20 * DMX\text{-Value}$ Example:           50 --> 3000K 100 --> 4000K 150 --> 5000K <i>*CCT overwrites the RGB setting</i>
95	0..255	0 - 100	<b>Dimmer of Pixel 16</b> (closed --> open)
96	0..1 2..255	0 - 0.4 0.8 - 100	<b>LEE Color Gel of Pixel 16</b> No effect Display LEE color gel (full list on page 171) <i>*LEE Color Gel overwrites both, RGB and CCT</i>
97	0 - 3 4 5 6 7 - 255	0 - 1.2 1.6 2.0 2.4 2.7 - 100	<b>Strobe for all Pixels</b> Off Random Fast Random Medium Random Slow Variable Strobe (0.4Hz --> 25Hz)



**57: RGBS RGBS (PIXEL = 16; STROBE = MULTIPLE)**

CHANNEL	VALUE	PERCENTAGE	FUNCTION
1	0 - 255	0 - 100	<b>Intensity Red of Pixel 1</b> (0% --> 100%)
2	0 - 255	0 - 100	<b>Intensity Green of Pixel 1</b> (0% --> 100%)
3	0 - 255	0 - 100	<b>Intensity Blue of Pixel 1</b> (0% --> 100%)
4	0 - 3	0 - 1.2	<b>Strobe of Pixel 1</b> Off
	4	1.6	Random Fast
	5	2.0	Random Medium
	6	2.4	Random Slow
	7 - 255	2.7 - 100	Variable Strobe (0.4Hz --> 25Hz)
5	0 - 255	0 - 100	<b>Intensity Red of Pixel 2</b> (0% --> 100%)
6	0 - 255	0 - 100	<b>Intensity Green of Pixel 2</b> (0% --> 100%)
7	0 - 255	0 - 100	<b>Intensity Blue of Pixel 2</b> (0% --> 100%)
8	0 - 3	0 - 1.2	<b>Strobe of Pixel 2</b> Off
	4	1.6	Random Fast
	5	2.0	Random Medium
	6	2.4	Random Slow
	7 - 255	2.7 - 100	Variable Strobe (0.4Hz --> 25Hz)
9	0 - 255	0 - 100	<b>Intensity Red of Pixel 3</b> (0% --> 100%)
10	0 - 255	0 - 100	<b>Intensity Green of Pixel 3</b> (0% --> 100%)
11	0 - 255	0 - 100	<b>Intensity Blue of Pixel 3</b> (0% --> 100%)
12	0 - 3	0 - 1.2	<b>Strobe of Pixel 3</b> Off
	4	1.6	Random Fast
	5	2.0	Random Medium
	6	2.4	Random Slow
	7 - 255	2.7 - 100	Variable Strobe (0.4Hz --> 25Hz)
13	0 - 255	0 - 100	<b>Intensity Red of Pixel 4</b> (0% --> 100%)
14	0 - 255	0 - 100	<b>Intensity Green of Pixel 4</b> (0% --> 100%)
15	0 - 255	0 - 100	<b>Intensity Blue of Pixel 4</b> (0% --> 100%)
16	0 - 3	0 - 1.2	<b>Strobe of Pixel 4</b> Off
	4	1.6	Random Fast
	5	2.0	Random Medium
	6	2.4	Random Slow
	7 - 255	2.7 - 100	Variable Strobe (0.4Hz --> 25Hz)
17	0 - 255	0 - 100	<b>Intensity Red of Pixel 5</b> (0% --> 100%)
18	0 - 255	0 - 100	<b>Intensity Green of Pixel 5</b> (0% --> 100%)
19	0 - 255	0 - 100	<b>Intensity Blue of Pixel 5</b> (0% --> 100%)
20	0 - 3	0 - 1.2	<b>Strobe of Pixel 5</b> Off
	4	1.6	Random Fast



	5	2.0	Random Medium
	6	2.4	Random Slow
	7 - 255	2.7 - 100	Variable Strobe (0.4Hz --> 25Hz)
21	0 - 255	0 - 100	<b>Intensity Red of Pixel 6 (0% --&gt; 100%)</b>
22	0 - 255	0 - 100	<b>Intensity Green of Pixel 6 (0% --&gt; 100%)</b>
23	0 - 255	0 - 100	<b>Intensity Blue of Pixel 6 (0% --&gt; 100%)</b>
24	0 - 3	0 - 1.2	<b>Strobe of Pixel 6</b> Off
	4	1.6	Random Fast
	5	2.0	Random Medium
	6	2.4	Random Slow
	7 - 255	2.7 - 100	Variable Strobe (0.4Hz --> 25Hz)
25	0 - 255	0 - 100	<b>Intensity Red of Pixel 7 (0% --&gt; 100%)</b>
26	0 - 255	0 - 100	<b>Intensity Green of Pixel 7 (0% --&gt; 100%)</b>
27	0 - 255	0 - 100	<b>Intensity Blue of Pixel 7 (0% --&gt; 100%)</b>
28	0 - 3	0 - 1.2	<b>Strobe of Pixel 7</b> Off
	4	1.6	Random Fast
	5	2.0	Random Medium
	6	2.4	Random Slow
	7 - 255	2.7 - 100	Variable Strobe (0.4Hz --> 25Hz)
29	0 - 255	0 - 100	<b>Intensity Red of Pixel 8 (0% --&gt; 100%)</b>
30	0 - 255	0 - 100	<b>Intensity Green of Pixel 8 (0% --&gt; 100%)</b>
31	0 - 255	0 - 100	<b>Intensity Blue of Pixel 8 (0% --&gt; 100%)</b>
32	0 - 3	0 - 1.2	<b>Strobe of Pixel 8</b> Off
	4	1.6	Random Fast
	5	2.0	Random Medium
	6	2.4	Random Slow
	7 - 255	2.7 - 100	Variable Strobe (0.4Hz --> 25Hz)
33	0 - 255	0 - 100	<b>Intensity Red of Pixel 9 (0% --&gt; 100%)</b>
34	0 - 255	0 - 100	<b>Intensity Green of Pixel 9 (0% --&gt; 100%)</b>
35	0 - 255	0 - 100	<b>Intensity Blue of Pixel 9 (0% --&gt; 100%)</b>
36	0 - 3	0 - 1.2	<b>Strobe of Pixel 9</b> Off
	4	1.6	Random Fast
	5	2.0	Random Medium
	6	2.4	Random Slow
	7 - 255	2.7 - 100	Variable Strobe (0.4Hz --> 25Hz)
37	0 - 255	0 - 100	<b>Intensity Red of Pixel 10 (0% --&gt; 100%)</b>
38	0 - 255	0 - 100	<b>Intensity Green of Pixel 10 (0% --&gt; 100%)</b>
39	0 - 255	0 - 100	<b>Intensity Blue of Pixel 10 (0% --&gt; 100%)</b>
40	0 - 3	0 - 1.2	<b>Strobe of Pixel 10</b> Off
	4	1.6	Random Fast



	5	2.0	Random Medium
	6	2.4	Random Slow
	7 - 255	2.7 - 100	Variable Strobe (0.4Hz --> 25Hz)
41	0 - 255	0 - 100	<b>Intensity Red of Pixel 11 (0% --&gt; 100%)</b>
42	0 - 255	0 - 100	<b>Intensity Green of Pixel 11 (0% --&gt; 100%)</b>
43	0 - 255	0 - 100	<b>Intensity Blue of Pixel 11 (0% --&gt; 100%)</b>
44	0 - 3	0 - 1.2	<b>Strobe of Pixel 11</b> Off
	4	1.6	Random Fast
	5	2.0	Random Medium
	6	2.4	Random Slow
	7 - 255	2.7 - 100	Variable Strobe (0.4Hz --> 25Hz)
45	0 - 255	0 - 100	<b>Intensity Red of Pixel 12 (0% --&gt; 100%)</b>
46	0 - 255	0 - 100	<b>Intensity Green of Pixel 12 (0% --&gt; 100%)</b>
47	0 - 255	0 - 100	<b>Intensity Blue of Pixel 12 (0% --&gt; 100%)</b>
48	0 - 3	0 - 1.2	<b>Strobe of Pixel 12</b> Off
	4	1.6	Random Fast
	5	2.0	Random Medium
	6	2.4	Random Slow
	7 - 255	2.7 - 100	Variable Strobe (0.4Hz --> 25Hz)
49	0 - 255	0 - 100	<b>Intensity Red of Pixel 13 (0% --&gt; 100%)</b>
50	0 - 255	0 - 100	<b>Intensity Green of Pixel 13 (0% --&gt; 100%)</b>
51	0 - 255	0 - 100	<b>Intensity Blue of Pixel 13 (0% --&gt; 100%)</b>
52	0 - 3	0 - 1.2	<b>Strobe of Pixel 13</b> Off
	4	1.6	Random Fast
	5	2.0	Random Medium
	6	2.4	Random Slow
	7 - 255	2.7 - 100	Variable Strobe (0.4Hz --> 25Hz)
53	0 - 255	0 - 100	<b>Intensity Red of Pixel 14 (0% --&gt; 100%)</b>
54	0 - 255	0 - 100	<b>Intensity Green of Pixel 14 (0% --&gt; 100%)</b>
55	0 - 255	0 - 100	<b>Intensity Blue of Pixel 14 (0% --&gt; 100%)</b>
56	0 - 3	0 - 1.2	<b>Strobe of Pixel 14</b> Off
	4	1.6	Random Fast
	5	2.0	Random Medium
	6	2.4	Random Slow
	7 - 255	2.7 - 100	Variable Strobe (0.4Hz --> 25Hz)
57	0 - 255	0 - 100	<b>Intensity Red of Pixel 15 (0% --&gt; 100%)</b>
58	0 - 255	0 - 100	<b>Intensity Green of Pixel 15 (0% --&gt; 100%)</b>
59	0 - 255	0 - 100	<b>Intensity Blue of Pixel 15 (0% --&gt; 100%)</b>
60	0 - 3	0 - 1.2	<b>Strobe of Pixel 15</b> Off
	4	1.6	Random Fast



	5	2.0	Random Medium
	6	2.4	Random Slow
	7 - 255	2.7 - 100	Variable Strobe (0.4Hz --> 25Hz)
61	0 - 255	0 - 100	<b>Intensity Red of Pixel 16 (0% --&gt; 100%)</b>
62	0 - 255	0 - 100	<b>Intensity Green of Pixel 16 (0% --&gt; 100%)</b>
63	0 - 255	0 - 100	<b>Intensity Blue of Pixel 16 (0% --&gt; 100%)</b>
64			<b>Strobe of Pixel 16</b>
	0 - 3	0 - 1.2	Off
	4	1.6	Random Fast
	5	2.0	Random Medium
	6	2.4	Random Slow
	7 - 255	2.7 - 100	Variable Strobe (0.4Hz --> 25Hz)

### 58: RGB RGB .. SS (PIXEL = 16; STROBE = MULTIPLE)

CHANNEL	VALUE	PERCENTAGE	FUNCTION
1	0 - 255	0 - 100	Intensity Red of Pixel 1 (0% --> 100%)
2	0 - 255	0 - 100	Intensity Green of Pixel 1 (0% --> 100%)
3	0 - 255	0 - 100	Intensity Blue of Pixel 1 (0% --> 100%)
4	0 - 255	0 - 100	Intensity Red of Pixel 2 (0% --> 100%)
5	0 - 255	0 - 100	Intensity Green of Pixel 2 (0% --> 100%)
6	0 - 255	0 - 100	Intensity Blue of Pixel 2 (0% --> 100%)
7	0 - 255	0 - 100	Intensity Red of Pixel 3 (0% --> 100%)
8	0 - 255	0 - 100	Intensity Green of Pixel 3 (0% --> 100%)
9	0 - 255	0 - 100	Intensity Blue of Pixel 3 (0% --> 100%)
10	0 - 255	0 - 100	Intensity Red of Pixel 4 (0% --> 100%)
11	0 - 255	0 - 100	Intensity Green of Pixel 4 (0% --> 100%)
12	0 - 255	0 - 100	Intensity Blue of Pixel 4 (0% --> 100%)
13	0 - 255	0 - 100	Intensity Red of Pixel 5 (0% --> 100%)
14	0 - 255	0 - 100	Intensity Green of Pixel 5 (0% --> 100%)
15	0 - 255	0 - 100	Intensity Blue of Pixel 5 (0% --> 100%)
16	0 - 255	0 - 100	Intensity Red of Pixel 6 (0% --> 100%)
17	0 - 255	0 - 100	Intensity Green of Pixel 6 (0% --> 100%)
18	0 - 255	0 - 100	Intensity Blue of Pixel 6 (0% --> 100%)
19	0 - 255	0 - 100	Intensity Red of Pixel 7 (0% --> 100%)
20	0 - 255	0 - 100	Intensity Green of Pixel 7 (0% --> 100%)
21	0 - 255	0 - 100	Intensity Blue of Pixel 7 (0% --> 100%)
22	0 - 255	0 - 100	Intensity Red of Pixel 8 (0% --> 100%)
23	0 - 255	0 - 100	Intensity Green of Pixel 8 (0% --> 100%)
24	0 - 255	0 - 100	Intensity Blue of Pixel 8 (0% --> 100%)
25	0 - 255	0 - 100	Intensity Red of Pixel 9 (0% --> 100%)
26	0 - 255	0 - 100	Intensity Green of Pixel 9 (0% --> 100%)
27	0 - 255	0 - 100	Intensity Blue of Pixel 9 (0% --> 100%)
28	0 - 255	0 - 100	Intensity Red of Pixel 10 (0% --> 100%)
29	0 - 255	0 - 100	Intensity Green of Pixel 10 (0% --> 100%)
30	0 - 255	0 - 100	Intensity Blue of Pixel 10 (0% --> 100%)
31	0 - 255	0 - 100	Intensity Red of Pixel 11 (0% --> 100%)
32	0 - 255	0 - 100	Intensity Green of Pixel 11 (0% --> 100%)
33	0 - 255	0 - 100	Intensity Blue of Pixel 11 (0% --> 100%)
34	0 - 255	0 - 100	Intensity Red of Pixel 12 (0% --> 100%)
35	0 - 255	0 - 100	Intensity Green of Pixel 12 (0% --> 100%)
36	0 - 255	0 - 100	Intensity Blue of Pixel 12 (0% --> 100%)
37	0 - 255	0 - 100	Intensity Red of Pixel 13 (0% --> 100%)
38	0 - 255	0 - 100	Intensity Green of Pixel 13 (0% --> 100%)
39	0 - 255	0 - 100	Intensity Blue of Pixel 13 (0% --> 100%)
40	0 - 255	0 - 100	Intensity Red of Pixel 14 (0% --> 100%)
41	0 - 255	0 - 100	Intensity Green of Pixel 14 (0% --> 100%)



42	0 - 255	0 - 100	<b>Intensity Blue of Pixel 14 (0% --&gt; 100%)</b>
43	0 - 255	0 - 100	<b>Intensity Red of Pixel 15 (0% --&gt; 100%)</b>
44	0 - 255	0 - 100	<b>Intensity Green of Pixel 15 (0% --&gt; 100%)</b>
45	0 - 255	0 - 100	<b>Intensity Blue of Pixel 15 (0% --&gt; 100%)</b>
46	0 - 255	0 - 100	<b>Intensity Red of Pixel 16 (0% --&gt; 100%)</b>
47	0 - 255	0 - 100	<b>Intensity Green of Pixel 16 (0% --&gt; 100%)</b>
48	0 - 255	0 - 100	<b>Intensity Blue of Pixel 16 (0% --&gt; 100%)</b>
49	0 - 3 4 5 6 7 - 255	0 - 1.2 1.6 2.0 2.4 2.7 - 100	<b>Strobe of Pixel 1</b> Off Random Fast Random Medium Random Slow Variable Strobe (0.4Hz --> 25Hz)
50	0 - 3 4 5 6 7 - 255	0 - 1.2 1.6 2.0 2.4 2.7 - 100	<b>Strobe of Pixel 2</b> Off Random Fast Random Medium Random Slow Variable Strobe (0.4Hz --> 25Hz)
51	0 - 3 4 5 6 7 - 255	0 - 1.2 1.6 2.0 2.4 2.7 - 100	<b>Strobe of Pixel 3</b> Off Random Fast Random Medium Random Slow Variable Strobe (0.4Hz --> 25Hz)
52	0 - 3 4 5 6 7 - 255	0 - 1.2 1.6 2.0 2.4 2.7 - 100	<b>Strobe of Pixel 4</b> Off Random Fast Random Medium Random Slow Variable Strobe (0.4Hz --> 25Hz)
53	0 - 3 4 5 6 7 - 255	0 - 1.2 1.6 2.0 2.4 2.7 - 100	<b>Strobe of Pixel 5</b> Off Random Fast Random Medium Random Slow Variable Strobe (0.4Hz --> 25Hz)
54	0 - 3 4 5 6 7 - 255	0 - 1.2 1.6 2.0 2.4 2.7 - 100	<b>Strobe of Pixel 6</b> Off Random Fast Random Medium Random Slow Variable Strobe (0.4Hz --> 25Hz)
55	0 - 3	0 - 1.2	<b>Strobe of Pixel 7</b> Off



	4 5 6 7 - 255	1.6 2.0 2.4 2.7 - 100	Random Fast Random Medium Random Slow Variable Strobe (0.4Hz --> 25Hz)
56	0 - 3 4 5 6 7 - 255	0 - 1.2 1.6 2.0 2.4 2.7 - 100	<b>Strobe of Pixel 8</b> Off Random Fast Random Medium Random Slow Variable Strobe (0.4Hz --> 25Hz)
57	0 - 3 4 5 6 7 - 255	0 - 1.2 1.6 2.0 2.4 2.7 - 100	<b>Strobe of Pixel 9</b> Off Random Fast Random Medium Random Slow Variable Strobe (0.4Hz --> 25Hz)
58	0 - 3 4 5 6 7 - 255	0 - 1.2 1.6 2.0 2.4 2.7 - 100	<b>Strobe of Pixel 10</b> Off Random Fast Random Medium Random Slow Variable Strobe (0.4Hz --> 25Hz)
59	0 - 3 4 5 6 7 - 255	0 - 1.2 1.6 2.0 2.4 2.7 - 100	<b>Strobe of Pixel 11</b> Off Random Fast Random Medium Random Slow Variable Strobe (0.4Hz --> 25Hz)
60	0 - 3 4 5 6 7 - 255	0 - 1.2 1.6 2.0 2.4 2.7 - 100	<b>Strobe of Pixel 12</b> Off Random Fast Random Medium Random Slow Variable Strobe (0.4Hz --> 25Hz)
61	0 - 3 4 5 6 7 - 255	0 - 1.2 1.6 2.0 2.4 2.7 - 100	<b>Strobe of Pixel 13</b> Off Random Fast Random Medium Random Slow Variable Strobe (0.4Hz --> 25Hz)
62	0 - 3 4 5 6	0 - 1.2 1.6 2.0 2.4	<b>Strobe of Pixel 14</b> Off Random Fast Random Medium Random Slow



	7 - 255	2.7 - 100	Variable Strobe (0.4Hz --> 25Hz)
63	0 - 3	0 - 1.2	<b>Strobe of Pixel 15</b> Off
	4	1.6	Random Fast
	5	2.0	Random Medium
	6	2.4	Random Slow
	7 - 255	2.7 - 100	Variable Strobe (0.4Hz --> 25Hz)
64	0 - 3	0 - 1.2	<b>Strobe of Pixel 16</b> Off
	4	1.6	Random Fast
	5	2.0	Random Medium
	6	2.4	Random Slow
	7 - 255	2.7 - 100	Variable Strobe (0.4Hz --> 25Hz)

### 59: RGBWS RGBWS (PIXEL = 16; STROBE = MULTIPLE)

CHANNEL	VALUE	PERCENTAGE	FUNCTION
1	0 - 255	0 - 100	<b>Intensity Red of Pixel 1</b> (0% --> 100%)
2	0 - 255	0 - 100	<b>Intensity Green of Pixel 1</b> (0% --> 100%)
3	0 - 255	0 - 100	<b>Intensity Blue of Pixel 1</b> (0% --> 100%)
4	0 - 255	0 - 100	<b>Intensity Emulated White of Pixel 1</b> (0% --> 100%)
5	0 - 3 4 5 6 7 - 255	0 - 1.2 1.6 2.0 2.4 2.7 - 100	<b>Strobe of Pixel 1</b> Off Random Fast Random Medium Random Slow Variable Strobe (0.4Hz --> 25Hz)
6	0 - 255	0 - 100	<b>Intensity Red of Pixel 2</b> (0% --> 100%)
7	0 - 255	0 - 100	<b>Intensity Green of Pixel 2</b> (0% --> 100%)
8	0 - 255	0 - 100	<b>Intensity Blue of Pixel 2</b> (0% --> 100%)
9	0 - 255	0 - 100	<b>Intensity Emulated White of Pixel 2</b> (0% --> 100%)
10	0 - 3 4 5 6 7 - 255	0 - 1.2 1.6 2.0 2.4 2.7 - 100	<b>Strobe of Pixel 2</b> Off Random Fast Random Medium Random Slow Variable Strobe (0.4Hz --> 25Hz)
11	0 - 255	0 - 100	<b>Intensity Red of Pixel 3</b> (0% --> 100%)
12	0 - 255	0 - 100	<b>Intensity Green of Pixel 3</b> (0% --> 100%)
13	0 - 255	0 - 100	<b>Intensity Blue of Pixel 3</b> (0% --> 100%)
14	0 - 255	0 - 100	<b>Intensity Emulated White of Pixel 3</b> (0% --> 100%)
15	0 - 3 4 5 6 7 - 255	0 - 1.2 1.6 2.0 2.4 2.7 - 100	<b>Strobe of Pixel 3</b> Off Random Fast Random Medium Random Slow Variable Strobe (0.4Hz --> 25Hz)
16	0 - 255	0 - 100	<b>Intensity Red of Pixel 4</b> (0% --> 100%)
17	0 - 255	0 - 100	<b>Intensity Green of Pixel 4</b> (0% --> 100%)
18	0 - 255	0 - 100	<b>Intensity Blue of Pixel 4</b> (0% --> 100%)
19	0 - 255	0 - 100	<b>Intensity Emulated White of Pixel 4</b> (0% --> 100%)
20	0 - 3 4 5 6 7 - 255	0 - 1.2 1.6 2.0 2.4 2.7 - 100	<b>Strobe of Pixel 4</b> Off Random Fast Random Medium Random Slow Variable Strobe (0.4Hz --> 25Hz)
21	0 - 255	0 - 100	<b>Intensity Red of Pixel 5</b> (0% --> 100%)

22	0 - 255	0 - 100	<b>Intensity Green of Pixel 5 (0% --&gt; 100%)</b>
23	0 - 255	0 - 100	<b>Intensity Blue of Pixel 5 (0% --&gt; 100%)</b>
24	0 - 255	0 - 100	<b>Intensity Emulated White of Pixel 5 (0% --&gt; 100%)</b>
25	0 - 3 4 5 6 7 - 255	0 - 1.2 1.6 2.0 2.4 2.7 - 100	<b>Strobe of Pixel 5</b> Off Random Fast Random Medium Random Slow Variable Strobe (0.4Hz --> 25Hz)
26	0 - 255	0 - 100	<b>Intensity Red of Pixel 6 (0% --&gt; 100%)</b>
27	0 - 255	0 - 100	<b>Intensity Green of Pixel 6 (0% --&gt; 100%)</b>
28	0 - 255	0 - 100	<b>Intensity Blue of Pixel 6 (0% --&gt; 100%)</b>
29	0 - 255	0 - 100	<b>Intensity Emulated White of Pixel 6 (0% --&gt; 100%)</b>
30	0 - 3 4 5 6 7 - 255	0 - 1.2 1.6 2.0 2.4 2.7 - 100	<b>Strobe of Pixel 6</b> Off Random Fast Random Medium Random Slow Variable Strobe (0.4Hz --> 25Hz)
31	0 - 255	0 - 100	<b>Intensity Red of Pixel 7 (0% --&gt; 100%)</b>
32	0 - 255	0 - 100	<b>Intensity Green of Pixel 7 (0% --&gt; 100%)</b>
33	0 - 255	0 - 100	<b>Intensity Blue of Pixel 7 (0% --&gt; 100%)</b>
34	0 - 255	0 - 100	<b>Intensity Emulated White of Pixel 7 (0% --&gt; 100%)</b>
35	0 - 3 4 5 6 7 - 255	0 - 1.2 1.6 2.0 2.4 2.7 - 100	<b>Strobe of Pixel 7</b> Off Random Fast Random Medium Random Slow Variable Strobe (0.4Hz --> 25Hz)
36	0 - 255	0 - 100	<b>Intensity Red of Pixel 8 (0% --&gt; 100%)</b>
37	0 - 255	0 - 100	<b>Intensity Green of Pixel 8 (0% --&gt; 100%)</b>
38	0 - 255	0 - 100	<b>Intensity Blue of Pixel 8 (0% --&gt; 100%)</b>
39	0 - 255	0 - 100	<b>Intensity Emulated White of Pixel 8 (0% --&gt; 100%)</b>
40	0 - 3 4 5 6 7 - 255	0 - 1.2 1.6 2.0 2.4 2.7 - 100	<b>Strobe of Pixel 8</b> Off Random Fast Random Medium Random Slow Variable Strobe (0.4Hz --> 25Hz)
41	0 - 255	0 - 100	<b>Intensity Red of Pixel 9 (0% --&gt; 100%)</b>
42	0 - 255	0 - 100	<b>Intensity Green of Pixel 9 (0% --&gt; 100%)</b>
43	0 - 255	0 - 100	<b>Intensity Blue of Pixel 9 (0% --&gt; 100%)</b>
44	0 - 255	0 - 100	<b>Intensity Emulated White of Pixel 9 (0% --&gt; 100%)</b>
45	0 - 3	0 - 1.2	<b>Strobe of Pixel 9</b> Off



	4	1.6	Random Fast
	5	2.0	Random Medium
	6	2.4	Random Slow
	7 - 255	2.7 - 100	Variable Strobe (0.4Hz --> 25Hz)
45	0 - 255	0 - 100	<b>Intensity Red of Pixel 10 (0% --&gt; 100%)</b>
47	0 - 255	0 - 100	<b>Intensity Green of Pixel 10 (0% --&gt; 100%)</b>
48	0 - 255	0 - 100	<b>Intensity Blue of Pixel 10 (0% --&gt; 100%)</b>
49	0 - 255	0 - 100	<b>Intensity Emulated White of Pixel 10 (0% --&gt; 100%)</b>
50	0 - 3	0 - 1.2	<b>Strobe of Pixel 10</b> Off
	4	1.6	Random Fast
	5	2.0	Random Medium
	6	2.4	Random Slow
	7 - 255	2.7 - 100	Variable Strobe (0.4Hz --> 25Hz)
51	0 - 255	0 - 100	<b>Intensity Red of Pixel 11 (0% --&gt; 100%)</b>
52	0 - 255	0 - 100	<b>Intensity Green of Pixel 11 (0% --&gt; 100%)</b>
53	0 - 255	0 - 100	<b>Intensity Blue of Pixel 11 (0% --&gt; 100%)</b>
54	0 - 255	0 - 100	<b>Intensity Emulated White of Pixel 11 (0% --&gt; 100%)</b>
55	0 - 3	0 - 1.2	<b>Strobe of Pixel 11</b> Off
	4	1.6	Random Fast
	5	2.0	Random Medium
	6	2.4	Random Slow
	7 - 255	2.7 - 100	Variable Strobe (0.4Hz --> 25Hz)
56	0 - 255	0 - 100	<b>Intensity Red of Pixel 12 (0% --&gt; 100%)</b>
57	0 - 255	0 - 100	<b>Intensity Green of Pixel 12 (0% --&gt; 100%)</b>
58	0 - 255	0 - 100	<b>Intensity Blue of Pixel 12 (0% --&gt; 100%)</b>
59	0 - 255	0 - 100	<b>Intensity Emulated White of Pixel 12 (0% --&gt; 100%)</b>
60	0 - 3	0 - 1.2	<b>Strobe of Pixel 12</b> Off
	4	1.6	Random Fast
	5	2.0	Random Medium
	6	2.4	Random Slow
	7 - 255	2.7 - 100	Variable Strobe (0.4Hz --> 25Hz)
61	0 - 255	0 - 100	<b>Intensity Red of Pixel 13 (0% --&gt; 100%)</b>
62	0 - 255	0 - 100	<b>Intensity Green of Pixel 13 (0% --&gt; 100%)</b>
63	0 - 255	0 - 100	<b>Intensity Blue of Pixel 13 (0% --&gt; 100%)</b>
64	0 - 255	0 - 100	<b>Intensity Emulated White of Pixel 13 (0% --&gt; 100%)</b>
65	0 - 3	0 - 1.2	<b>Strobe of Pixel 13</b> Off
	4	1.6	Random Fast
	5	2.0	Random Medium
	6	2.4	Random Slow
	7 - 255	2.7 - 100	Variable Strobe (0.4Hz --> 25Hz)
66	0 - 255	0 - 100	<b>Intensity Red of Pixel 14 (0% --&gt; 100%)</b>



67	0 - 255	0 - 100	<b>Intensity Green of Pixel 14 (0% --&gt; 100%)</b>
68	0 - 255	0 - 100	<b>Intensity Blue of Pixel 14 (0% --&gt; 100%)</b>
69	0 - 255	0 - 100	<b>Intensity Emulated White of Pixel 14 (0% --&gt; 100%)</b>
70	0 - 3 4 5 6 7 - 255	0 - 1.2 1.6 2.0 2.4 2.7 - 100	<b>Strobe of Pixel 14</b> Off Random Fast Random Medium Random Slow Variable Strobe (0.4Hz --> 25Hz)
71	0 - 255	0 - 100	<b>Intensity Red of Pixel 15 (0% --&gt; 100%)</b>
72	0 - 255	0 - 100	<b>Intensity Green of Pixel 15 (0% --&gt; 100%)</b>
73	0 - 255	0 - 100	<b>Intensity Blue of Pixel 15 (0% --&gt; 100%)</b>
74	0 - 255	0 - 100	<b>Intensity Emulated White of Pixel 15 (0% --&gt; 100%)</b>
75	0 - 3 4 5 6 7 - 255	0 - 1.2 1.6 2.0 2.4 2.7 - 100	<b>Strobe of Pixel 15</b> Off Random Fast Random Medium Random Slow Variable Strobe (0.4Hz --> 25Hz)
76	0 - 255	0 - 100	<b>Intensity Red of Pixel 16 (0% --&gt; 100%)</b>
77	0 - 255	0 - 100	<b>Intensity Green of Pixel 16 (0% --&gt; 100%)</b>
78	0 - 255	0 - 100	<b>Intensity Blue of Pixel 16 (0% --&gt; 100%)</b>
79	0 - 255	0 - 100	<b>Intensity Emulated White of Pixel 16 (0% --&gt; 100%)</b>
80	0 - 3 4 5 6 7 - 255	0 - 1.2 1.6 2.0 2.4 2.7 - 100	<b>Strobe of Pixel 16</b> Off Random Fast Random Medium Random Slow Variable Strobe (0.4Hz --> 25Hz)



## 60: RGBAWS RGBAWS (PIXEL = 16; STROBE = MULTIPLE)

CHANNEL	VALUE	PERCENTAGE	FUNCTION
1	0 - 255	0 - 100	Intensity Red of Pixel 1 (0% --> 100%)
2	0 - 255	0 - 100	Intensity Green of Pixel 1 (0% --> 100%)
3	0 - 255	0 - 100	Intensity Blue of Pixel 1 (0% --> 100%)
4	0 - 255	0 - 100	Intensity Amber of Pixel 1 (0% --> 100%)
5	0 - 255	0 - 100	Intensity Emulated White of Pixel 1 (0% --> 100%)
6	0 - 3 4 5 6 7 - 255	0 - 1.2 1.6 2.0 2.4 2.7 - 100	<b>Strobe of Pixel 1</b> Off Random Fast Random Medium Random Slow Variable Strobe (0.4Hz --> 25Hz)
7	0 - 255	0 - 100	Intensity Red of Pixel 2 (0% --> 100%)
8	0 - 255	0 - 100	Intensity Green of Pixel 2 (0% --> 100%)
9	0 - 255	0 - 100	Intensity Blue of Pixel 2 (0% --> 100%)
10	0 - 255	0 - 100	Intensity Amber of Pixel 2 (0% --> 100%)
11	0 - 255	0 - 100	Intensity Emulated White of Pixel 2 (0% --> 100%)
12	0 - 3 4 5 6 7 - 255	0 - 1.2 1.6 2.0 2.4 2.7 - 100	<b>Strobe of Pixel 2</b> Off Random Fast Random Medium Random Slow Variable Strobe (0.4Hz --> 25Hz)
13	0 - 255	0 - 100	Intensity Red of Pixel 3 (0% --> 100%)
14	0 - 255	0 - 100	Intensity Green of Pixel 3 (0% --> 100%)
15	0 - 255	0 - 100	Intensity Blue of Pixel 3 (0% --> 100%)
16	0 - 255	0 - 100	Intensity Amber of Pixel 3 (0% --> 100%)
17	0 - 255	0 - 100	Intensity Emulated White of Pixel 3 (0% --> 100%)
18	0 - 3 4 5 6 7 - 255	0 - 1.2 1.6 2.0 2.4 2.7 - 100	<b>Strobe of Pixel 3</b> Off Random Fast Random Medium Random Slow Variable Strobe (0.4Hz --> 25Hz)
19	0 - 255	0 - 100	Intensity Red of Pixel 4 (0% --> 100%)
20	0 - 255	0 - 100	Intensity Green of Pixel 4 (0% --> 100%)
21	0 - 255	0 - 100	Intensity Blue of Pixel 4 (0% --> 100%)
22	0 - 255	0 - 100	Intensity Amber of Pixel 4 (0% --> 100%)
23	0 - 255	0 - 100	Intensity Emulated White of Pixel 4 (0% --> 100%)
24	0 - 3 4 5	0 - 1.2 1.6 2.0	<b>Strobe of Pixel 4</b> Off Random Fast Random Medium



	6 7 - 255	2.4 2.7 - 100	Random Slow Variable Strobe (0.4Hz --> 25Hz)
25	0 - 255	0 - 100	<b>Intensity Red of Pixel 5 (0% --&gt; 100%)</b>
26	0 - 255	0 - 100	<b>Intensity Green of Pixel 5 (0% --&gt; 100%)</b>
27	0 - 255	0 - 100	<b>Intensity Blue of Pixel 5 (0% --&gt; 100%)</b>
28	0 - 255	0 - 100	<b>Intensity Amber of Pixel 5 (0% --&gt; 100%)</b>
29	0 - 255	0 - 100	<b>Intensity Emulated White of Pixel 5 (0% --&gt; 100%)</b>
30	0 - 3 4 5 6 7 - 255	0 - 1.2 1.6 2.0 2.4 2.7 - 100	<b>Strobe of Pixel 5</b> Off Random Fast Random Medium Random Slow Variable Strobe (0.4Hz --> 25Hz)
31	0 - 255	0 - 100	<b>Intensity Red of Pixel 6 (0% --&gt; 100%)</b>
32	0 - 255	0 - 100	<b>Intensity Green of Pixel 6 (0% --&gt; 100%)</b>
33	0 - 255	0 - 100	<b>Intensity Blue of Pixel 6 (0% --&gt; 100%)</b>
34	0 - 255	0 - 100	<b>Intensity Amber of Pixel 6 (0% --&gt; 100%)</b>
35	0 - 255	0 - 100	<b>Intensity Emulated White of Pixel 6 (0% --&gt; 100%)</b>
36	0 - 3 4 5 6 7 - 255	0 - 1.2 1.6 2.0 2.4 2.7 - 100	<b>Strobe of Pixel 6</b> Off Random Fast Random Medium Random Slow Variable Strobe (0.4Hz --> 25Hz)
37	0 - 255	0 - 100	<b>Intensity Red of Pixel 7 (0% --&gt; 100%)</b>
38	0 - 255	0 - 100	<b>Intensity Green of Pixel 7 (0% --&gt; 100%)</b>
39	0 - 255	0 - 100	<b>Intensity Blue of Pixel 7 (0% --&gt; 100%)</b>
40	0 - 255	0 - 100	<b>Intensity Amber of Pixel 7 (0% --&gt; 100%)</b>
41	0 - 255	0 - 100	<b>Intensity Emulated White of Pixel 7 (0% --&gt; 100%)</b>
42	0 - 3 4 5 6 7 - 255	0 - 1.2 1.6 2.0 2.4 2.7 - 100	<b>Strobe of Pixel 7</b> Off Random Fast Random Medium Random Slow Variable Strobe (0.4Hz --> 25Hz)
43	0 - 255	0 - 100	<b>Intensity Red of Pixel 8 (0% --&gt; 100%)</b>
44	0 - 255	0 - 100	<b>Intensity Green of Pixel 8 (0% --&gt; 100%)</b>
45	0 - 255	0 - 100	<b>Intensity Blue of Pixel 8 (0% --&gt; 100%)</b>
46	0 - 255	0 - 100	<b>Intensity Amber of Pixel 8 (0% --&gt; 100%)</b>
47	0 - 255	0 - 100	<b>Intensity Emulated White of Pixel 8 (0% --&gt; 100%)</b>
48	0 - 3 4 5 6	0 - 1.2 1.6 2.0 2.4	<b>Strobe of Pixel 8</b> Off Random Fast Random Medium Random Slow



	7 - 255	2.7 - 100	Variable Strobe (0.4Hz --> 25Hz)
49	0 - 255	0 - 100	<b>Intensity Red of Pixel 9 (0% --&gt; 100%)</b>
50	0 - 255	0 - 100	<b>Intensity Green of Pixel 9 (0% --&gt; 100%)</b>
51	0 - 255	0 - 100	<b>Intensity Blue of Pixel 9 (0% --&gt; 100%)</b>
52	0 - 255	0 - 100	<b>Intensity Amber of Pixel 9 (0% --&gt; 100%)</b>
53	0 - 255	0 - 100	<b>Intensity Emulated White of Pixel 9 (0% --&gt; 100%)</b>
54	0 - 3 4 5 6 7 - 255	0 - 1.2 1.6 2.0 2.4 2.7 - 100	<b>Strobe of Pixel 9</b> Off Random Fast Random Medium Random Slow Variable Strobe (0.4Hz --> 25Hz)
55	0 - 255	0 - 100	<b>Intensity Red of Pixel 10 (0% --&gt; 100%)</b>
56	0 - 255	0 - 100	<b>Intensity Green of Pixel 10 (0% --&gt; 100%)</b>
57	0 - 255	0 - 100	<b>Intensity Blue of Pixel 10 (0% --&gt; 100%)</b>
58	0 - 255	0 - 100	<b>Intensity Amber of Pixel 10 (0% --&gt; 100%)</b>
59	0 - 255	0 - 100	<b>Intensity Emulated White of Pixel 10 (0% --&gt; 100%)</b>
60	0 - 3 4 5 6 7 - 255	0 - 1.2 1.6 2.0 2.4 2.7 - 100	<b>Strobe of Pixel 10</b> Off Random Fast Random Medium Random Slow Variable Strobe (0.4Hz --> 25Hz)
61	0 - 255	0 - 100	<b>Intensity Red of Pixel 11 (0% --&gt; 100%)</b>
62	0 - 255	0 - 100	<b>Intensity Green of Pixel 11 (0% --&gt; 100%)</b>
63	0 - 255	0 - 100	<b>Intensity Blue of Pixel 11 (0% --&gt; 100%)</b>
64	0 - 255	0 - 100	<b>Intensity Amber of Pixel 11 (0% --&gt; 100%)</b>
65	0 - 255	0 - 100	<b>Intensity Emulated White of Pixel 11 (0% --&gt; 100%)</b>
66	0 - 3 4 5 6 7 - 255	0 - 1.2 1.6 2.0 2.4 2.7 - 100	<b>Strobe of Pixel 11</b> Off Random Fast Random Medium Random Slow Variable Strobe (0.4Hz --> 25Hz)
67	0 - 255	0 - 100	<b>Intensity Red of Pixel 12 (0% --&gt; 100%)</b>
68	0 - 255	0 - 100	<b>Intensity Green of Pixel 12 (0% --&gt; 100%)</b>
69	0 - 255	0 - 100	<b>Intensity Blue of Pixel 12 (0% --&gt; 100%)</b>
70	0 - 255	0 - 100	<b>Intensity Amber of Pixel 12 (0% --&gt; 100%)</b>
71	0 - 255	0 - 100	<b>Intensity Emulated White of Pixel 12 (0% --&gt; 100%)</b>
72	0 - 3 4 5 6 7 - 255	0 - 1.2 1.6 2.0 2.4 2.7 - 100	<b>Strobe of Pixel 12</b> Off Random Fast Random Medium Random Slow Variable Strobe (0.4Hz --> 25Hz)



73	0 - 255	0 - 100	<b>Intensity Red of Pixel 13 (0% --&gt; 100%)</b>
74	0 - 255	0 - 100	<b>Intensity Green of Pixel 13 (0% --&gt; 100%)</b>
75	0 - 255	0 - 100	<b>Intensity Blue of Pixel 13 (0% --&gt; 100%)</b>
76	0 - 255	0 - 100	<b>Intensity Amber of Pixel 13 (0% --&gt; 100%)</b>
77	0 - 255	0 - 100	<b>Intensity Emulated White of Pixel 13 (0% --&gt; 100%)</b>
78	0 - 3 4 5 6 7 - 255	0 - 1.2 1.6 2.0 2.4 2.7 - 100	<b>Strobe of Pixel 13</b> Off Random Fast Random Medium Random Slow Variable Strobe (0.4Hz --> 25Hz)
79	0 - 255	0 - 100	<b>Intensity Red of Pixel 14 (0% --&gt; 100%)</b>
80	0 - 255	0 - 100	<b>Intensity Green of Pixel 14 (0% --&gt; 100%)</b>
81	0 - 255	0 - 100	<b>Intensity Blue of Pixel 14 (0% --&gt; 100%)</b>
82	0 - 255	0 - 100	<b>Intensity Amber of Pixel 14 (0% --&gt; 100%)</b>
83	0 - 255	0 - 100	<b>Intensity Emulated White of Pixel 14 (0% --&gt; 100%)</b>
84	0 - 3 4 5 6 7 - 255	0 - 1.2 1.6 2.0 2.4 2.7 - 100	<b>Strobe of Pixel 14</b> Off Random Fast Random Medium Random Slow Variable Strobe (0.4Hz --> 25Hz)
85	0 - 255	0 - 100	<b>Intensity Red of Pixel 15 (0% --&gt; 100%)</b>
86	0 - 255	0 - 100	<b>Intensity Green of Pixel 15 (0% --&gt; 100%)</b>
87	0 - 255	0 - 100	<b>Intensity Blue of Pixel 15 (0% --&gt; 100%)</b>
88	0 - 255	0 - 100	<b>Intensity Amber of Pixel 15 (0% --&gt; 100%)</b>
89	0 - 255	0 - 100	<b>Intensity Emulated White of Pixel 15 (0% --&gt; 100%)</b>
90	0 - 3 4 5 6 7 - 255	0 - 1.2 1.6 2.0 2.4 2.7 - 100	<b>Strobe of Pixel 15</b> Off Random Fast Random Medium Random Slow Variable Strobe (0.4Hz --> 25Hz)
91	0 - 255	0 - 100	<b>Intensity Red of Pixel 16 (0% --&gt; 100%)</b>
92	0 - 255	0 - 100	<b>Intensity Green of Pixel 16 (0% --&gt; 100%)</b>
93	0 - 255	0 - 100	<b>Intensity Blue of Pixel 16 (0% --&gt; 100%)</b>
94	0 - 255	0 - 100	<b>Intensity Amber of Pixel 16 (0% --&gt; 100%)</b>
95	0 - 255	0 - 100	<b>Intensity Emulated White of Pixel 16 (0% --&gt; 100%)</b>
96	0 - 3 4 5 6 7 - 255	0 - 1.2 1.6 2.0 2.4 2.7 - 100	<b>Strobe of Pixel 16</b> Off Random Fast Random Medium Random Slow Variable Strobe (0.4Hz --> 25Hz)

## 61: DIM RGBS DIM RGBS (PIXEL = 16; STROBE = MULTIPLE)

CHANNEL	VALUE	PERCENTAGE	FUNCTION
1	0 - 255	0 - 100	<b>Dimmer of Pixel 1</b> (closed --> open)
2	0 - 255	0 - 100	<b>Intensity Red of Pixel 1</b> (0% --> 100%)
3	0 - 255	0 - 100	<b>Intensity Green of Pixel 1</b> (0% --> 100%)
4	0 - 255	0 - 100	<b>Intensity Blue of Pixel 1</b> (0% --> 100%)
5	0 - 3 4 5 6 7 - 255	0 - 1.2 1.6 2.0 2.4 2.7 - 100	<b>Strobe of Pixel 1</b> Off Random Fast Random Medium Random Slow Variable Strobe (0.4Hz --> 25Hz)
6	0 - 255	0 - 100	<b>Dimmer of Pixel 2</b> (closed --> open)
7	0 - 255	0 - 100	<b>Intensity Red of Pixel 2</b> (0% --> 100%)
8	0 - 255	0 - 100	<b>Intensity Green of Pixel 2</b> (0% --> 100%)
9	0 - 255	0 - 100	<b>Intensity Blue of Pixel 2</b> (0% --> 100%)
10	0 - 3 4 5 6 7 - 255	0 - 1.2 1.6 2.0 2.4 2.7 - 100	<b>Strobe of Pixel 2</b> Off Random Fast Random Medium Random Slow Variable Strobe (0.4Hz --> 25Hz)
11	0 - 255	0 - 100	<b>Dimmer of Pixel 3</b> (closed --> open)
12	0 - 255	0 - 100	<b>Intensity Red of Pixel 3</b> (0% --> 100%)
13	0 - 255	0 - 100	<b>Intensity Green of Pixel 3</b> (0% --> 100%)
14	0 - 255	0 - 100	<b>Intensity Blue of Pixel 3</b> (0% --> 100%)
15	0 - 3 4 5 6 7 - 255	0 - 1.2 1.6 2.0 2.4 2.7 - 100	<b>Strobe of Pixel 3</b> Off Random Fast Random Medium Random Slow Variable Strobe (0.4Hz --> 25Hz)
16	0 - 255	0 - 100	<b>Dimmer of Pixel 4</b> (closed --> open)
17	0 - 255	0 - 100	<b>Intensity Red of Pixel 4</b> (0% --> 100%)
18	0 - 255	0 - 100	<b>Intensity Green of Pixel 4</b> (0% --> 100%)
19	0 - 255	0 - 100	<b>Intensity Blue of Pixel 4</b> (0% --> 100%)
20	0 - 3 4 5 6 7 - 255	0 - 1.2 1.6 2.0 2.4 2.7 - 100	<b>Strobe of Pixel 4</b> Off Random Fast Random Medium Random Slow Variable Strobe (0.4Hz --> 25Hz)
21	0 - 255	0 - 100	<b>Dimmer of Pixel 5</b> (closed --> open)
22	0 - 255	0 - 100	<b>Intensity Red of Pixel 5</b> (0% --> 100%)



23	0 - 255	0 - 100	<b>Intensity Green of Pixel 5 (0% --&gt; 100%)</b>
24	0 - 255	0 - 100	<b>Intensity Blue of Pixel 5 (0% --&gt; 100%)</b>
25	0 - 3 4 5 6 7 - 255	0 - 1.2 1.6 2.0 2.4 2.7 - 100	<b>Strobe of Pixel 5</b> Off Random Fast Random Medium Random Slow Variable Strobe (0.4Hz --> 25Hz)
26	0 - 255	0 - 100	<b>Dimmer of Pixel 6 (closed --&gt; open)</b>
27	0 - 255	0 - 100	<b>Intensity Red of Pixel 6 (0% --&gt; 100%)</b>
28	0 - 255	0 - 100	<b>Intensity Green of Pixel 6 (0% --&gt; 100%)</b>
29	0 - 255	0 - 100	<b>Intensity Blue of Pixel 6 (0% --&gt; 100%)</b>
30	0 - 3 4 5 6 7 - 255	0 - 1.2 1.6 2.0 2.4 2.7 - 100	<b>Strobe of Pixel 6</b> Off Random Fast Random Medium Random Slow Variable Strobe (0.4Hz --> 25Hz)
31	0 - 255	0 - 100	<b>Dimmer of Pixel 7 (closed --&gt; open)</b>
32	0 - 255	0 - 100	<b>Intensity Red of Pixel 7 (0% --&gt; 100%)</b>
33	0 - 255	0 - 100	<b>Intensity Green of Pixel 7 (0% --&gt; 100%)</b>
34	0 - 255	0 - 100	<b>Intensity Blue of Pixel 7 (0% --&gt; 100%)</b>
35	0 - 3 4 5 6 7 - 255	0 - 1.2 1.6 2.0 2.4 2.7 - 100	<b>Strobe of Pixel 7</b> Off Random Fast Random Medium Random Slow Variable Strobe (0.4Hz --> 25Hz)
36	0 - 255	0 - 100	<b>Dimmer of Pixel 8 (closed --&gt; open)</b>
37	0 - 255	0 - 100	<b>Intensity Red of Pixel 8 (0% --&gt; 100%)</b>
38	0 - 255	0 - 100	<b>Intensity Green of Pixel 8 (0% --&gt; 100%)</b>
39	0 - 255	0 - 100	<b>Intensity Blue of Pixel 8 (0% --&gt; 100%)</b>
40	0 - 3 4 5 6 7 - 255	0 - 1.2 1.6 2.0 2.4 2.7 - 100	<b>Strobe of Pixel 8</b> Off Random Fast Random Medium Random Slow Variable Strobe (0.4Hz --> 25Hz)
41	0 - 255	0 - 100	<b>Dimmer of Pixel 9 (closed --&gt; open)</b>
42	0 - 255	0 - 100	<b>Intensity Red of Pixel 9 (0% --&gt; 100%)</b>
43	0 - 255	0 - 100	<b>Intensity Green of Pixel 9 (0% --&gt; 100%)</b>
44	0 - 255	0 - 100	<b>Intensity Blue of Pixel 9 (0% --&gt; 100%)</b>
45	0 - 3 4	0 - 1.2 1.6	<b>Strobe of Pixel 9</b> Off Random Fast



	5	2.0	Random Medium
	6	2.4	Random Slow
	7 - 255	2.7 - 100	Variable Strobe (0.4Hz --> 25Hz)
45	0 - 255	0 - 100	<b>Dimmer of Pixel 10</b> (closed --> open)
47	0 - 255	0 - 100	<b>Intensity Red of Pixel 10</b> (0% --> 100%)
48	0 - 255	0 - 100	<b>Intensity Green of Pixel 10</b> (0% --> 100%)
49	0 - 255	0 - 100	<b>Intensity Blue of Pixel 10</b> (0% --> 100%)
50	0 - 3	0 - 1.2	<b>Strobe of Pixel 10</b> Off
	4	1.6	Random Fast
	5	2.0	Random Medium
	6	2.4	Random Slow
	7 - 255	2.7 - 100	Variable Strobe (0.4Hz --> 25Hz)
51	0 - 255	0 - 100	<b>Dimmer of Pixel 11</b> (closed --> open)
52	0 - 255	0 - 100	<b>Intensity Red of Pixel 11</b> (0% --> 100%)
53	0 - 255	0 - 100	<b>Intensity Green of Pixel 11</b> (0% --> 100%)
54	0 - 255	0 - 100	<b>Intensity Blue of Pixel 11</b> (0% --> 100%)
55	0 - 3	0 - 1.2	<b>Strobe of Pixel 11</b> Off
	4	1.6	Random Fast
	5	2.0	Random Medium
	6	2.4	Random Slow
	7 - 255	2.7 - 100	Variable Strobe (0.4Hz --> 25Hz)
56	0 - 255	0 - 100	<b>Dimmer of Pixel 12</b> (closed --> open)
57	0 - 255	0 - 100	<b>Intensity Red of Pixel 12</b> (0% --> 100%)
58	0 - 255	0 - 100	<b>Intensity Green of Pixel 12</b> (0% --> 100%)
59	0 - 255	0 - 100	<b>Intensity Blue of Pixel 12</b> (0% --> 100%)
60	0 - 3	0 - 1.2	<b>Strobe of Pixel 12</b> Off
	4	1.6	Random Fast
	5	2.0	Random Medium
	6	2.4	Random Slow
	7 - 255	2.7 - 100	Variable Strobe (0.4Hz --> 25Hz)
61	0 - 255	0 - 100	<b>Dimmer of Pixel 13</b> (closed --> open)
62	0 - 255	0 - 100	<b>Intensity Red of Pixel 13</b> (0% --> 100%)
63	0 - 255	0 - 100	<b>Intensity Green of Pixel 13</b> (0% --> 100%)
64	0 - 255	0 - 100	<b>Intensity Blue of Pixel 13</b> (0% --> 100%)
65	0 - 3	0 - 1.2	<b>Strobe of Pixel 13</b> Off
	4	1.6	Random Fast
	5	2.0	Random Medium
	6	2.4	Random Slow
	7 - 255	2.7 - 100	Variable Strobe (0.4Hz --> 25Hz)
66	0 - 255	0 - 100	<b>Dimmer of Pixel 14</b> (closed --> open)
67	0 - 255	0 - 100	<b>Intensity Red of Pixel 14</b> (0% --> 100%)



68	0 - 255	0 - 100	<b>Intensity Green of Pixel 14 (0% --&gt; 100%)</b>
69	0 - 255	0 - 100	<b>Intensity Blue of Pixel 14 (0% --&gt; 100%)</b>
70	0 - 3 4 5 6 7 - 255	0 - 1.2 1.6 2.0 2.4 2.7 - 100	<b>Strobe of Pixel 14</b> Off Random Fast Random Medium Random Slow Variable Strobe (0.4Hz --> 25Hz)
71	0 - 255	0 - 100	<b>Dimmer of Pixel 15 (closed --&gt; open)</b>
72	0 - 255	0 - 100	<b>Intensity Red of Pixel 15 (0% --&gt; 100%)</b>
73	0 - 255	0 - 100	<b>Intensity Green of Pixel 15 (0% --&gt; 100%)</b>
74	0 - 255	0 - 100	<b>Intensity Blue of Pixel 15 (0% --&gt; 100%)</b>
75	0 - 3 4 5 6 7 - 255	0 - 1.2 1.6 2.0 2.4 2.7 - 100	<b>Strobe of Pixel 15</b> Off Random Fast Random Medium Random Slow Variable Strobe (0.4Hz --> 25Hz)
76	0 - 255	0 - 100	<b>Dimmer of Pixel 16 (closed --&gt; open)</b>
77	0 - 255	0 - 100	<b>Intensity Red of Pixel 16 (0% --&gt; 100%)</b>
78	0 - 255	0 - 100	<b>Intensity Green of Pixel 16 (0% --&gt; 100%)</b>
79	0 - 255	0 - 100	<b>Intensity Blue of Pixel 16 (0% --&gt; 100%)</b>
80	0 - 3 4 5 6 7 - 255	0 - 1.2 1.6 2.0 2.4 2.7 - 100	<b>Strobe of Pixel 16</b> Off Random Fast Random Medium Random Slow Variable Strobe (0.4Hz --> 25Hz)

## 62: DIM RGBWS DIM RGBWS (PIXEL = 16; STROBE = MULTIPLE)

CHANNEL	VALUE	PERCENTAGE	FUNCTION
1	0 - 255	0 - 100	<b>Dimmer of Pixel 1</b> (closed --> open)
2	0 - 255	0 - 100	<b>Intensity Red of Pixel 1</b> (0% --> 100%)
3	0 - 255	0 - 100	<b>Intensity Green of Pixel 1</b> (0% --> 100%)
4	0 - 255	0 - 100	<b>Intensity Blue of Pixel 1</b> (0% --> 100%)
5	0 - 255	1 - 100	<b>Intensity Emulated White of Pixel 1</b> (0% --> 100%)
6	0 - 3	0 - 1.2	<b>Strobe of Pixel 1</b> Off
	4	1.6	Random Fast
	5	2.0	Random Medium
	6	2.4	Random Slow
	7 - 255	2.7 - 100	Variable Strobe (0.4Hz --> 25Hz)
7	0 - 255	0 - 100	<b>Dimmer of Pixel 2</b> (closed --> open)
8	0 - 255	0 - 100	<b>Intensity Red of Pixel 2</b> (0% --> 100%)
9	0 - 255	0 - 100	<b>Intensity Green of Pixel 2</b> (0% --> 100%)
10	0 - 255	0 - 100	<b>Intensity Blue of Pixel 2</b> (0% --> 100%)
11	0 - 255	0 - 100	<b>Intensity Emulated White of Pixel 2</b> (0% --> 100%)
12	0 - 3	0 - 1.2	<b>Strobe of Pixel 2</b> Off
	4	1.6	Random Fast
	5	2.0	Random Medium
	6	2.4	Random Slow
	7 - 255	2.7 - 100	Variable Strobe (0.4Hz --> 25Hz)
13	0 - 255	0 - 100	<b>Dimmer of Pixel 3</b> (closed --> open)
14	0 - 255	0 - 100	<b>Intensity Red of Pixel 3</b> (0% --> 100%)
15	0 - 255	0 - 100	<b>Intensity Green of Pixel 3</b> (0% --> 100%)
16	0 - 255	0 - 100	<b>Intensity Blue of Pixel 3</b> (0% --> 100%)
17	0 - 255	0 - 100	<b>Intensity Emulated White of Pixel 3</b> (0% --> 100%)
18	0 - 3	0 - 1.2	<b>Strobe of Pixel 3</b> Off
	4	1.6	Random Fast
	5	2.0	Random Medium
	6	2.4	Random Slow
	7 - 255	2.7 - 100	Variable Strobe (0.4Hz --> 25Hz)
19	0 - 255	0 - 100	<b>Dimmer of Pixel 4</b> (closed --> open)
20	0 - 255	0 - 100	<b>Intensity Red of Pixel 4</b> (0% --> 100%)
21	0 - 255	0 - 100	<b>Intensity Green of Pixel 4</b> (0% --> 100%)
22	0 - 255	0 - 100	<b>Intensity Blue of Pixel 4</b> (0% --> 100%)
23	0 - 255	1 - 100	<b>Intensity Emulated White of Pixel 4</b> (0% --> 100%)
24	0 - 3	0 - 1.2	<b>Strobe of Pixel 4</b> Off
	4	1.6	Random Fast
	5	2.0	Random Medium
	6	2.4	Random Slow



	7 - 255	2.7 - 100	Variable Strobe (0.4Hz --> 25Hz)
25	0 - 255	0 - 100	<b>Dimmer of Pixel 5</b> (closed --> open)
26	0 - 255	0 - 100	<b>Intensity Red of Pixel 5</b> (0% --> 100%)
27	0 - 255	0 - 100	<b>Intensity Green of Pixel 5</b> (0% --> 100%)
28	0 - 255	0 - 100	<b>Intensity Blue of Pixel 5</b> (0% --> 100%)
29	0 - 255	0 - 100	<b>Intensity Emulated White of Pixel 5</b> (0% --> 100%)
30	0 - 3 4 5 6 7 - 255	0 - 1.2 1.6 2.0 2.4 2.7 - 100	<b>Strobe of Pixel 5</b> Off Random Fast Random Medium Random Slow Variable Strobe (0.4Hz --> 25Hz)
31	0 - 255	0 - 100	<b>Dimmer of Pixel 6</b> (closed --> open)
32	0 - 255	0 - 100	<b>Intensity Red of Pixel 6</b> (0% --> 100%)
33	0 - 255	0 - 100	<b>Intensity Green of Pixel 6</b> (0% --> 100%)
34	0 - 255	0 - 100	<b>Intensity Blue of Pixel 6</b> (0% --> 100%)
35	0 - 255	0 - 100	<b>Intensity Emulated White of Pixel 6</b> (0% --> 100%)
36	0 - 3 4 5 6 7 - 255	0 - 1.2 1.6 2.0 2.4 2.7 - 100	<b>Strobe of Pixel 6</b> Off Random Fast Random Medium Random Slow Variable Strobe (0.4Hz --> 25Hz)
37	0 - 255	0 - 100	<b>Dimmer of Pixel 7</b> (closed --> open)
38	0 - 255	0 - 100	<b>Intensity Red of Pixel 7</b> (0% --> 100%)
39	0 - 255	0 - 100	<b>Intensity Green of Pixel 7</b> (0% --> 100%)
40	0 - 255	0 - 100	<b>Intensity Blue of Pixel 7</b> (0% --> 100%)
41	0 - 255	0 - 100	<b>Intensity Emulated White of Pixel 7</b> (0% --> 100%)
42	0 - 3 4 5 6 7 - 255	0 - 1.2 1.6 2.0 2.4 2.7 - 100	<b>Strobe of Pixel 7</b> Off Random Fast Random Medium Random Slow Variable Strobe (0.4Hz --> 25Hz)
43	0 - 255	0 - 100	<b>Dimmer of Pixel 8</b> (closed --> open)
44	0 - 255	0 - 100	<b>Intensity Red of Pixel 8</b> (0% --> 100%)
45	0 - 255	0 - 100	<b>Intensity Green of Pixel 8</b> (0% --> 100%)
46	0 - 255	0 - 100	<b>Intensity Blue of Pixel 8</b> (0% --> 100%)
47	0 - 255	0 - 100	<b>Intensity Emulated White of Pixel 8</b> (0% --> 100%)
48	0 - 3 4 5 6 7 - 255	0 - 1.2 1.6 2.0 2.4 2.7 - 100	<b>Strobe of Pixel 8</b> Off Random Fast Random Medium Random Slow Variable Strobe (0.4Hz --> 25Hz)
49	0 - 255	0 - 100	<b>Dimmer of Pixel 9</b> (closed --> open)



50	0 - 255	0 - 100	<b>Intensity Red of Pixel 9</b> (0% --> 100%)
51	0 - 255	0 - 100	<b>Intensity Green of Pixel 9</b> (0% --> 100%)
52	0 - 255	0 - 100	<b>Intensity Blue of Pixel 9</b> (0% --> 100%)
53	0 - 255	0 - 100	<b>Intensity Emulated White of Pixel 9</b> (0% --> 100%)
54	0 - 3	0 - 1.2	<b>Strobe of Pixel 9</b> Off
	4	1.6	Random Fast
	5	2.0	Random Medium
	6	2.4	Random Slow
	7 - 255	2.7 - 100	Variable Strobe (0.4Hz --> 25Hz)
55	0 - 255	0 - 100	<b>Dimmer of Pixel 10</b> (closed --> open)
56	0 - 255	0 - 100	<b>Intensity Red of Pixel 10</b> (0% --> 100%)
57	0 - 255	0 - 100	<b>Intensity Green of Pixel 10</b> (0% --> 100%)
58	0 - 255	0 - 100	<b>Intensity Blue of Pixel 10</b> (0% --> 100%)
59	0 - 255	0 - 100	<b>Intensity Emulated White of Pixel 10</b> (0% --> 100%)
60	0 - 3	0 - 1.2	<b>Strobe of Pixel 10</b> Off
	4	1.6	Random Fast
	5	2.0	Random Medium
	6	2.4	Random Slow
	7 - 255	2.7 - 100	Variable Strobe (0.4Hz --> 25Hz)
61	0 - 255	0 - 100	<b>Dimmer of Pixel 11</b> (closed --> open)
62	0 - 255	0 - 100	<b>Intensity Red of Pixel 11</b> (0% --> 100%)
63	0 - 255	0 - 100	<b>Intensity Green of Pixel 11</b> (0% --> 100%)
64	0 - 255	0 - 100	<b>Intensity Blue of Pixel 11</b> (0% --> 100%)
64	0 - 255	0 - 100	<b>Intensity Emulated White of Pixel 11</b> (0% --> 100%)
66	0 - 3	0 - 1.2	<b>Strobe of Pixel 11</b> Off
	4	1.6	Random Fast
	5	2.0	Random Medium
	6	2.4	Random Slow
	7 - 255	2.7 - 100	Variable Strobe (0.4Hz --> 25Hz)
67	0 - 255	0 - 100	<b>Dimmer of Pixel 12</b> (closed --> open)
68	0 - 255	0 - 100	<b>Intensity Red of Pixel 12</b> (0% --> 100%)
69	0 - 255	0 - 100	<b>Intensity Green of Pixel 12</b> (0% --> 100%)
70	0 - 255	0 - 100	<b>Intensity Blue of Pixel 12</b> (0% --> 100%)
71	0 - 255	0 - 100	<b>Intensity Emulated White of Pixel 12</b> (0% --> 100%)
72	0 - 3	0 - 1.2	<b>Strobe of Pixel 12</b> Off
	4	1.6	Random Fast
	5	2.0	Random Medium
	6	2.4	Random Slow
	7 - 255	2.7 - 100	Variable Strobe (0.4Hz --> 25Hz)
73	0 - 255	0 - 100	<b>Dimmer of Pixel 13</b> (closed --> open)
74	0 - 255	0 - 100	<b>Intensity Red of Pixel 13</b> (0% --> 100%)
75	0 - 255	0 - 100	<b>Intensity Green of Pixel 13</b> (0% --> 100%)



76	0 - 255	0 - 100	<b>Intensity Blue of Pixel 13 (0% --&gt; 100%)</b>
77	0 - 255	0 - 100	<b>Intensity Emulated White of Pixel 13 (0% --&gt; 100%)</b>
78	0 - 3 4 5 6 7 - 255	0 - 1.2 1.6 2.0 2.4 2.7 - 100	<b>Strobe of Pixel 13</b> Off Random Fast Random Medium Random Slow Variable Strobe (0.4Hz --> 25Hz)
79	0 - 255	0 - 100	<b>Dimmer of Pixel 14 (closed --&gt; open)</b>
80	0 - 255	0 - 100	<b>Intensity Red of Pixel 14 (0% --&gt; 100%)</b>
81	0 - 255	0 - 100	<b>Intensity Green of Pixel 14 (0% --&gt; 100%)</b>
82	0 - 255	0 - 100	<b>Intensity Blue of Pixel 14 (0% --&gt; 100%)</b>
83	0 - 255	0 - 100	<b>Intensity Emulated White of Pixel 14 (0% --&gt; 100%)</b>
84	0 - 3 4 5 6 7 - 255	0 - 1.2 1.6 2.0 2.4 2.7 - 100	<b>Strobe of Pixel 14</b> Off Random Fast Random Medium Random Slow Variable Strobe (0.4Hz --> 25Hz)
85	0 - 255	0 - 100	<b>Dimmer of Pixel 15 (closed --&gt; open)</b>
86	0 - 255	0 - 100	<b>Intensity Red of Pixel 15 (0% --&gt; 100%)</b>
87	0 - 255	0 - 100	<b>Intensity Green of Pixel 15 (0% --&gt; 100%)</b>
88	0 - 255	0 - 100	<b>Intensity Blue of Pixel 15 (0% --&gt; 100%)</b>
89	0 - 255	0 - 100	<b>Intensity Emulated White of Pixel 15 (0% --&gt; 100%)</b>
90	0 - 3 4 5 6 7 - 255	0 - 1.2 1.6 2.0 2.4 2.7 - 100	<b>Strobe of Pixel 15</b> Off Random Fast Random Medium Random Slow Variable Strobe (0.4Hz --> 25Hz)
91	0 - 255	0 - 100	<b>Dimmer of Pixel 16 (closed --&gt; open)</b>
92	0 - 255	0 - 100	<b>Intensity Red of Pixel 16 (0% --&gt; 100%)</b>
93	0 - 255	0 - 100	<b>Intensity Green of Pixel 16 (0% --&gt; 100%)</b>
94	0 - 255	0 - 100	<b>Intensity Blue of Pixel 16 (0% --&gt; 100%)</b>
95	0 - 255	0 - 100	<b>Intensity Emulated White of Pixel 16 (0% --&gt; 100%)</b>
96	0 - 3 4 5 6 7 - 255	0 - 1.2 1.6 2.0 2.4 2.7 - 100	<b>Strobe of Pixel 16</b> Off Random Fast Random Medium Random Slow Variable Strobe (0.4Hz --> 25Hz)

### 63: DIM RGBAWS DIM RGBAWS (PIXEL = 1 6; STROBE = MULTIPLE)

CHANNEL	VALUE	PERCENTAGE	FUNCTION
1	0 - 255	0 - 100	<b>Dimmer of Pixel 1</b> (closed --> open)
2	0 - 255	0 - 100	<b>Intensity Red of Pixel 1</b> (0% --> 100%)
3	0 - 255	0 - 100	<b>Intensity Green of Pixel 1</b> (0% --> 100%)
4	0 - 255	0 - 100	<b>Intensity Blue of Pixel 1</b> (0% --> 100%)
5	0 - 255	0 - 100	<b>Intensity Amber of Pixel 1</b> (0% --> 100%)
6	0 - 255	1 - 100	<b>Intensity Emulated White of Pixel 1</b> (0% --> 100%)
7	0 - 3 4 5 6 7 - 255	0 - 1.2 1.6 2.0 2.4 2.7 - 100	<b>Strobe of Pixel 1</b> Off Random Fast Random Medium Random Slow Variable Strobe (0.4Hz --> 25Hz)
8	0 - 255	0 - 100	<b>Dimmer of Pixel 2</b> (closed --> open)
9	0 - 255	0 - 100	<b>Intensity Red of Pixel 2</b> (0% --> 100%)
10	0 - 255	0 - 100	<b>Intensity Green of Pixel 2</b> (0% --> 100%)
11	0 - 255	0 - 100	<b>Intensity Blue of Pixel 2</b> (0% --> 100%)
12	0 - 255	0 - 100	<b>Intensity Amber of Pixel 2</b> (0% --> 100%)
13	0 - 255	0 - 100	<b>Intensity Emulated White of Pixel 2</b> (0% --> 100%)
14	0 - 3 4 5 6 7 - 255	0 - 1.2 1.6 2.0 2.4 2.7 - 100	<b>Strobe of Pixel 2</b> Off Random Fast Random Medium Random Slow Variable Strobe (0.4Hz --> 25Hz)
15	0 - 255	0 - 100	<b>Dimmer of Pixel 3</b> (closed --> open)
16	0 - 255	0 - 100	<b>Intensity Red of Pixel 3</b> (0% --> 100%)
17	0 - 255	0 - 100	<b>Intensity Green of Pixel 3</b> (0% --> 100%)
18	0 - 255	0 - 100	<b>Intensity Blue of Pixel 3</b> (0% --> 100%)
19	0 - 255	0 - 100	<b>Intensity Amber of Pixel 3</b> (0% --> 100%)
20	0 - 255	0 - 100	<b>Intensity Emulated White of Pixel 3</b> (0% --> 100%)
21	0 - 3 4 5 6 7 - 255	0 - 1.2 1.6 2.0 2.4 2.7 - 100	<b>Strobe of Pixel 3</b> Off Random Fast Random Medium Random Slow Variable Strobe (0.4Hz --> 25Hz)
22	0 - 255	0 - 100	<b>Dimmer of Pixel 4</b> (closed --> open)
23	0 - 255	0 - 100	<b>Intensity Red of Pixel 4</b> (0% --> 100%)
24	0 - 255	0 - 100	<b>Intensity Green of Pixel 4</b> (0% --> 100%)
25	0 - 255	0 - 100	<b>Intensity Blue of Pixel 4</b> (0% --> 100%)
26	0 - 255	0 - 100	<b>Intensity Amber of Pixel 4</b> (0% --> 100%)



27	0 - 255	1 - 100	<b>Intensity Emulated White of Pixel 4 (0% --&gt; 100%)</b>
28	0 - 3	0 - 1.2	<b>Strobe of Pixel 4</b> Off
	4	1.6	Random Fast
	5	2.0	Random Medium
	6	2.4	Random Slow
	7 - 255	2.7 - 100	Variable Strobe (0.4Hz --> 25Hz)
29	0 - 255	0 - 100	<b>Dimmer of Pixel 5 (closed --&gt; open)</b>
30	0 - 255	0 - 100	<b>Intensity Red of Pixel 5 (0% --&gt; 100%)</b>
31	0 - 255	0 - 100	<b>Intensity Green of Pixel 5 (0% --&gt; 100%)</b>
32	0 - 255	0 - 100	<b>Intensity Blue of Pixel 5 (0% --&gt; 100%)</b>
33	0 - 255	0 - 100	<b>Intensity Amber of Pixel 5 (0% --&gt; 100%)</b>
34	0 - 255	0 - 100	<b>Intensity Emulated White of Pixel 5 (0% --&gt; 100%)</b>
35	0 - 3	0 - 1.2	<b>Strobe of Pixel 5</b> Off
	4	1.6	Random Fast
	5	2.0	Random Medium
	6	2.4	Random Slow
	7 - 255	2.7 - 100	Variable Strobe (0.4Hz --> 25Hz)
36	0 - 255	0 - 100	<b>Dimmer of Pixel 6 (closed --&gt; open)</b>
37	0 - 255	0 - 100	<b>Intensity Red of Pixel 6 (0% --&gt; 100%)</b>
38	0 - 255	0 - 100	<b>Intensity Green of Pixel 6 (0% --&gt; 100%)</b>
39	0 - 255	0 - 100	<b>Intensity Blue of Pixel 6 (0% --&gt; 100%)</b>
40	0 - 255	0 - 100	<b>Intensity Amber of Pixel 6 (0% --&gt; 100%)</b>
41	0 - 255	0 - 100	<b>Intensity Emulated White of Pixel 6 (0% --&gt; 100%)</b>
42	0 - 3	0 - 1.2	<b>Strobe of Pixel 6</b> Off
	4	1.6	Random Fast
	5	2.0	Random Medium
	6	2.4	Random Slow
	7 - 255	2.7 - 100	Variable Strobe (0.4Hz --> 25Hz)
43	0 - 255	0 - 100	<b>Dimmer of Pixel 7 (closed --&gt; open)</b>
44	0 - 255	0 - 100	<b>Intensity Red of Pixel 7 (0% --&gt; 100%)</b>
45	0 - 255	0 - 100	<b>Intensity Green of Pixel 7 (0% --&gt; 100%)</b>
46	0 - 255	0 - 100	<b>Intensity Blue of Pixel 7 (0% --&gt; 100%)</b>
47	0 - 255	0 - 100	<b>Intensity Amber of Pixel 7 (0% --&gt; 100%)</b>
48	0 - 255	0 - 100	<b>Intensity Emulated White of Pixel 7 (0% --&gt; 100%)</b>
49	0 - 3	0 - 1.2	<b>Strobe of Pixel 7</b> Off
	4	1.6	Random Fast
	5	2.0	Random Medium
	6	2.4	Random Slow
	7 - 255	2.7 - 100	Variable Strobe (0.4Hz --> 25Hz)
50	0 - 255	0 - 100	<b>Dimmer of Pixel 8 (closed --&gt; open)</b>



51	0 - 255	0 - 100	<b>Intensity Red of Pixel 8 (0% --&gt; 100%)</b>
52	0 - 255	0 - 100	<b>Intensity Green of Pixel 8 (0% --&gt; 100%)</b>
53	0 - 255	0 - 100	<b>Intensity Blue of Pixel 8 (0% --&gt; 100%)</b>
54	0 - 255	0 - 100	<b>Intensity Amber of Pixel 8 (0% --&gt; 100%)</b>
55	0 - 255	0 - 100	<b>Intensity Emulated White of Pixel 8 (0% --&gt; 100%)</b>
56	0 - 3 4 5 6 7 - 255	0 - 1.2 1.6 2.0 2.4 2.7 - 100	<b>Strobe of Pixel 8</b> Off Random Fast Random Medium Random Slow Variable Strobe (0.4Hz --> 25Hz)
57	0 - 255	0 - 100	<b>Dimmer of Pixel 9 (closed --&gt; open)</b>
58	0 - 255	0 - 100	<b>Intensity Red of Pixel 9 (0% --&gt; 100%)</b>
59	0 - 255	0 - 100	<b>Intensity Green of Pixel 9 (0% --&gt; 100%)</b>
60	0 - 255	0 - 100	<b>Intensity Blue of Pixel 9 (0% --&gt; 100%)</b>
61	0 - 255	0 - 100	<b>Intensity Amber of Pixel 9 (0% --&gt; 100%)</b>
62	0 - 255	0 - 100	<b>Intensity Emulated White of Pixel 9 (0% --&gt; 100%)</b>
63	0 - 3 4 5 6 7 - 255	0 - 1.2 1.6 2.0 2.4 2.7 - 100	<b>Strobe of Pixel 9</b> Off Random Fast Random Medium Random Slow Variable Strobe (0.4Hz --> 25Hz)
64	0 - 255	0 - 100	<b>Dimmer of Pixel 10 (closed --&gt; open)</b>
65	0 - 255	0 - 100	<b>Intensity Red of Pixel 10 (0% --&gt; 100%)</b>
66	0 - 255	0 - 100	<b>Intensity Green of Pixel 10 (0% --&gt; 100%)</b>
67	0 - 255	0 - 100	<b>Intensity Blue of Pixel 10 (0% --&gt; 100%)</b>
68	0 - 255	0 - 100	<b>Intensity Amber of Pixel 10 (0% --&gt; 100%)</b>
69	0 - 255	0 - 100	<b>Intensity Emulated White of Pixel 10 (0% --&gt; 100%)</b>
70	0 - 3 4 5 6 7 - 255	0 - 1.2 1.6 2.0 2.4 2.7 - 100	<b>Strobe of Pixel 10</b> Off Random Fast Random Medium Random Slow Variable Strobe (0.4Hz --> 25Hz)
71	0 - 255	0 - 100	<b>Dimmer of Pixel 11 (closed --&gt; open)</b>
72	0 - 255	0 - 100	<b>Intensity Red of Pixel 11 (0% --&gt; 100%)</b>
73	0 - 255	0 - 100	<b>Intensity Green of Pixel 11 (0% --&gt; 100%)</b>
74	0 - 255	0 - 100	<b>Intensity Blue of Pixel 11 (0% --&gt; 100%)</b>
75	0 - 255	0 - 100	<b>Intensity Amber of Pixel 11 (0% --&gt; 100%)</b>
76	0 - 255	0 - 100	<b>Intensity Emulated White of Pixel 11 (0% --&gt; 100%)</b>
77	0 - 3 4	0 - 1.2 1.6	<b>Strobe of Pixel 11</b> Off Random Fast



	5	2.0	Random Medium
	6	2.4	Random Slow
	7 - 255	2.7 - 100	Variable Strobe (0.4Hz --> 25Hz)
78	0 - 255	0 - 100	<b>Dimmer of Pixel 12</b> (closed --> open)
79	0 - 255	0 - 100	<b>Intensity Red of Pixel 12</b> (0% --> 100%)
80	0 - 255	0 - 100	<b>Intensity Green of Pixel 12</b> (0% --> 100%)
81	0 - 255	0 - 100	<b>Intensity Blue of Pixel 12</b> (0% --> 100%)
82	0 - 255	0 - 100	<b>Intensity Amber of Pixel 12</b> (0% --> 100%)
83	0 - 255	0 - 100	<b>Intensity Emulated White of Pixel 12</b> (0% --> 100%)
84	0 - 3	0 - 1.2	<b>Strobe of Pixel 12</b> Off
	4	1.6	Random Fast
	5	2.0	Random Medium
	6	2.4	Random Slow
	7 - 255	2.7 - 100	Variable Strobe (0.4Hz --> 25Hz)
85	0 - 255	0 - 100	<b>Dimmer of Pixel 13</b> (closed --> open)
86	0 - 255	0 - 100	<b>Intensity Red of Pixel 13</b> (0% --> 100%)
87	0 - 255	0 - 100	<b>Intensity Green of Pixel 13</b> (0% --> 100%)
88	0 - 255	0 - 100	<b>Intensity Blue of Pixel 13</b> (0% --> 100%)
89	0 - 255	0 - 100	<b>Intensity Amber of Pixel 13</b> (0% --> 100%)
90	0 - 255	0 - 100	<b>Intensity Emulated White of Pixel 13</b> (0% --> 100%)
91	0 - 3	0 - 1.2	<b>Strobe of Pixel 13</b> Off
	4	1.6	Random Fast
	5	2.0	Random Medium
	6	2.4	Random Slow
	7 - 255	2.7 - 100	Variable Strobe (0.4Hz --> 25Hz)
92	0 - 255	0 - 100	<b>Dimmer of Pixel 14</b> (closed --> open)
93	0 - 255	0 - 100	<b>Intensity Red of Pixel 14</b> (0% --> 100%)
94	0 - 255	0 - 100	<b>Intensity Green of Pixel 14</b> (0% --> 100%)
95	0 - 255	0 - 100	<b>Intensity Blue of Pixel 14</b> (0% --> 100%)
96	0 - 255	0 - 100	<b>Intensity Amber of Pixel 14</b> (0% --> 100%)
97	0 - 255	0 - 100	<b>Intensity Emulated White of Pixel 14</b> (0% --> 100%)
98	0 - 3	0 - 1.2	<b>Strobe of Pixel 14</b> Off
	4	1.6	Random Fast
	5	2.0	Random Medium
	6	2.4	Random Slow
	7 - 255	2.7 - 100	Variable Strobe (0.4Hz --> 25Hz)
99	0 - 255	0 - 100	<b>Dimmer of Pixel 15</b> (closed --> open)
100	0 - 255	0 - 100	<b>Intensity Red of Pixel 15</b> (0% --> 100%)
101	0 - 255	0 - 100	<b>Intensity Green of Pixel 15</b> (0% --> 100%)
102	0 - 255	0 - 100	<b>Intensity Blue of Pixel 15</b> (0% --> 100%)
103	0 - 255	0 - 100	<b>Intensity Amber of Pixel 15</b> (0% --> 100%)



104	0 - 255	0 - 100	<b>Intensity Emulated White of Pixel 15</b> (0% --> 100%)
105	0 - 3 4 5 6 7 - 255	0 - 1.2 1.6 2.0 2.4 2.7 - 100	<b>Strobe of Pixel 15</b> Off Random Fast Random Medium Random Slow Variable Strobe (0.4Hz --> 25Hz)
106	0 - 255	0 - 100	<b>Dimmer of Pixel 16</b> (closed --> open)
107	0 - 255	0 - 100	<b>Intensity Red of Pixel 16</b> (0% --> 100%)
108	0 - 255	0 - 100	<b>Intensity Green of Pixel 16</b> (0% --> 100%)
109	0 - 255	0 - 100	<b>Intensity Blue of Pixel 16</b> (0% --> 100%)
110	0 - 255	0 - 100	<b>Intensity Amber of Pixel 16</b> (0% --> 100%)
111	0 - 255	0 - 100	<b>Intensity Emulated White of Pixel 16</b> (0% --> 100%)
112	0 - 3 4 5 6 7 - 255	0 - 1.2 1.6 2.0 2.4 2.7 - 100	<b>Strobe of Pixel 16</b> Off Random Fast Random Medium Random Slow Variable Strobe (0.4Hz --> 25Hz)

## 64: RGB CCT DIM IND S (PIXEL = 16; STROBE = MULTIPLE)

CHANNEL	VALUE	PERCENTAGE	FUNCTION
1	0 - 255	0 - 100	<b>Intensity Red of Pixel 1</b> (0% --> 100%)
2	0 - 255	0 - 100	<b>Intensity Green of Pixel 1</b> (0% --> 100%)
3	0 - 255	0 - 100	<b>Intensity Blue of Pixel 1</b> (0% --> 100%)
4	0 - 4 4 - 255	0 - 1.5 1.6-100	<b>Color Temperature (CCT) of Pixel 1</b> No effect Display color temperature Formula: CCT = 2000 + 20*DMX-Value Example: 50 --> 3000K 100 -> 4000K 150 --> 5000K <i>*CCT overwrites the RGB setting</i>
5	0..255	0 - 100	<b>Dimmer of Pixel 1</b> (closed --> open)
6	0..1 2..255	0 - 0.4 0.8 - 100	<b>LEE Color Gel of Pixel 1</b> No effect Display LEE color gel (full list on page 171) <i>*LEE Color Gel overwrites both, RGB and CCT</i>
7	0 - 3 4 5 6 7 - 255	0 - 1.2 1.6 2.0 2.4 2.7 - 100	<b>Strobe of Pixel 1</b> Off Random Fast Random Medium Random Slow Variable Strobe (0.4Hz --> 25Hz)
8	0 - 255	0 - 100	<b>Intensity Red of Pixel 2</b> (0% --> 100%)
9	0 - 255	0 - 100	<b>Intensity Green of Pixel 2</b> (0% --> 100%)
10	0 - 255	0 - 100	<b>Intensity Blue of Pixel 2</b> (0% --> 100%)
11	0 - 4 4 - 255	0 - 1.5 1.6-100	<b>Color Temperature (CCT) of Pixel 2</b> No effect Display color temperature Formula: CCT = 2000 + 20*DMX-Value Example: 50 --> 3000K 100 -> 4000K 150 --> 5000K <i>*CCT overwrites the RGB setting</i>
12	0..255	0 - 100	<b>Dimmer of Pixel 2</b> (closed --> open)
13	0..1 2..255	0 - 0.4 0.8 - 100	<b>LEE Color Gel of Pixel 2</b> No effect Display LEE color gel (full list on page 171) <i>*LEE Color Gel overwrites both, RGB and CCT</i>
14	0 - 3 4 5 6	0 - 1.2 1.6 2.0 2.4	<b>Strobe of Pixel 2</b> Off Random Fast Random Medium Random Slow

	7 - 255	2.7 - 100	Variable Strobe (0.4Hz --> 25Hz)
15	0 - 255	0 - 100	<b>Intensity Red of Pixel 3</b> (0% --> 100%)
16	0 - 255	0 - 100	<b>Intensity Green of Pixel 3</b> (0% --> 100%)
17	0 - 255	0 - 100	<b>Intensity Blue of Pixel 3</b> (0% --> 100%)
18	0 - 4 4 - 255	0 - 1.5 1.6-100	<b>Color Temperature (CCT) of Pixel 3</b> No effect Display color temperature Formula: $CCT = 2000 + 20 * DMX-Value$ Example: 50 --> 3000K 100 -> 4000K 150 --> 5000K  <i>*CCT overwrites the RGB setting</i>
19	0..255	0 - 100	<b>Dimmer of Pixel 3</b> (closed --> open)
20	0..1 2..255	0 - 0.4 0.8 - 100	<b>LEE Color Gel of Pixel 3</b> No effect Display LEE color gel (full list on page 171) <i>*LEE Color Gel overwrites both, RGB and CCT</i>
21	0 - 3 4 5 6 7 - 255	0 - 1.2 1.6 2.0 2.4 2.7 - 100	<b>Strobe of Pixel 3</b> Off Random Fast Random Medium Random Slow Variable Strobe (0.4Hz --> 25Hz)
22	0 - 255	0 - 100	<b>Intensity Red of Pixel 4</b> (0% --> 100%)
23	0 - 255	0 - 100	<b>Intensity Green of Pixel 4</b> (0% --> 100%)
24	0 - 255	0 - 100	<b>Intensity Blue of Pixel 4</b> (0% --> 100%)
25	0 - 4 4 - 255	0 - 1.5 1.6-100	<b>Color Temperature (CCT) of Pixel 4</b> No effect Display color temperature Formula: $CCT = 2000 + 20 * DMX-Value$ Example: 50 --> 3000K 100 -> 4000K 150 --> 5000K  <i>*CCT overwrites the RGB setting</i>
26	0..255	0 - 100	<b>Dimmer of Pixel 4</b> (closed --> open)
27	0..1 2..255	0 - 0.4 0.8 - 100	<b>LEE Color Gel of Pixel 4</b> No effect Display LEE color gel (full list on page 171) <i>*LEE Color Gel overwrites both, RGB and CCT</i>
28	0 - 3 4 5 6 7 - 255	0 - 1.2 1.6 2.0 2.4 2.7 - 100	<b>Strobe of Pixel 4</b> Off Random Fast Random Medium Random Slow Variable Strobe (0.4Hz --> 25Hz)
29	0 - 255	0 - 100	<b>Intensity Red of Pixel 5</b> (0% --> 100%)

30	0 - 255	0 - 100	<b>Intensity Green of Pixel 5</b> (0% --> 100%)
31	0 - 255	0 - 100	<b>Intensity Blue of Pixel 5</b> (0% --> 100%)
32	0 - 4 4 - 255	0 - 1.5 1.6-100	<b>Color Temperature (CCT) of Pixel 5</b> No effect Display color temperature Formula: CCT = 2000 + 20*DMX-Value Example: 50 --> 3000K 100 -> 4000K 150 --> 5000K <i>*CCT overwrites the RGB setting</i>
33	0..255	0 - 100	<b>Dimmer of Pixel 5</b> (closed --> open)
34	0..1 2..255	0 - 0.4 0.8 - 100	<b>LEE Color Gel of Pixel 5</b> No effect Display LEE color gel (full list on page 171) <i>*LEE Color Gel overwrites both, RGB and CCT</i>
35	0 - 3 4 5 6 7 - 255	0 - 1.2 1.6 2.0 2.4 2.7 - 100	<b>Strobe of Pixel 5</b> Off Random Fast Random Medium Random Slow Variable Strobe (0.4Hz --> 25Hz)
36	0 - 255	0 - 100	<b>Intensity Red of Pixel 6</b> (0% --> 100%)
37	0 - 255	0 - 100	<b>Intensity Green of Pixel 6</b> (0% --> 100%)
38	0 - 255	0 - 100	<b>Intensity Blue of Pixel 6</b> (0% --> 100%)
39	0 - 4 4 - 255	0 - 1.5 1.6-100	<b>Color Temperature (CCT) of Pixel 6</b> No effect Display color temperature Formula: CCT = 2000 + 20*DMX-Value Example: 50 --> 3000K 100 -> 4000K 150 --> 5000K <i>*CCT overwrites the RGB setting</i>
40	0..255	0 - 100	<b>Dimmer of Pixel 6</b> (closed --> open)
41	0..1 2..255	0 - 0.4 0.8 - 100	<b>LEE Color Gel of Pixel 6</b> No effect Display LEE color gel (full list on page 171) <i>*LEE Color Gel overwrites both, RGB and CCT</i>
42	0 - 3 4 5 6 7 - 255	0 - 1.2 1.6 2.0 2.4 2.7 - 100	<b>Strobe of Pixel 6</b> Off Random Fast Random Medium Random Slow Variable Strobe (0.4Hz --> 25Hz)
43	0 - 255	0 - 100	<b>Intensity Red of Pixel 7</b> (0% --> 100%)
44	0 - 255	0 - 100	<b>Intensity Green of Pixel 7</b> (0% --> 100%)
45	0 - 255	0 - 100	<b>Intensity Blue of Pixel 7</b> (0% --> 100%)

46	0 - 4 4 - 255	0 - 1.5 1.6-100	<b>Color Temperature (CCT) of Pixel 7</b> No effect Display color temperature Formula: $CCT = 2000 + 20 * DMX-Value$ Example:       50 --> 3000K 100 -> 4000K 150 --> 5000K  <i>*CCT overwrites the RGB setting</i>
47	0..255	0 - 100	<b>Dimmer of Pixel 7</b> (closed --> open)
48	0..1 2..255	0 - 0.4 0.8 - 100	<b>LEE Color Gel of Pixel 7</b> No effect Display LEE color gel (full list on page 171) <i>*LEE Color Gel overwrites both, RGB and CCT</i>
49	0 - 3 4 5 6 7 - 255	0 - 1.2 1.6 2.0 2.4 2.7 - 100	<b>Strobe of Pixel 7</b> Off Random Fast Random Medium Random Slow Variable Strobe (0.4Hz --> 25Hz)
50	0 - 255	0 - 100	<b>Intensity Red of Pixel 8</b> (0% --> 100%)
51	0 - 255	0 - 100	<b>Intensity Green of Pixel 8</b> (0% --> 100%)
52	0 - 255	0 - 100	<b>Intensity Blue of Pixel 8</b> (0% --> 100%)
53	0 - 4 4 - 255	0 - 1.5 1.6-100	<b>Color Temperature (CCT) of Pixel 8</b> No effect Display color temperature Formula: $CCT = 2000 + 20 * DMX-Value$ Example:       50 --> 3000K 100 -> 4000K 150 --> 5000K  <i>*CCT overwrites the RGB setting</i>
54	0..255	0 - 100	<b>Dimmer of Pixel 8</b> (closed --> open)
55	0..1 2..255	0 - 0.4 0.8 - 100	<b>LEE Color Gel of Pixel 8</b> No effect Display LEE color gel (full list on page 171) <i>*LEE Color Gel overwrites both, RGB and CCT</i>
56	0 - 3 4 5 6 7 - 255	0 - 1.2 1.6 2.0 2.4 2.7 - 100	<b>Strobe of Pixel 8</b> Off Random Fast Random Medium Random Slow Variable Strobe (0.4Hz --> 25Hz)
57	0 - 255	0 - 100	<b>Intensity Red of Pixel 9</b> (0% --> 100%)
58	0 - 255	0 - 100	<b>Intensity Green of Pixel 9</b> (0% --> 100%)
59	0 - 255	0 - 100	<b>Intensity Blue of Pixel 9</b> (0% --> 100%)
60	0 - 4	0 - 1.5	<b>Color Temperature (CCT) of Pixel 9</b> No effect

	4 - 255	1.6-100	<p>Display color temperature          Formula: <math>CCT = 2000 + 20 * DMX-Value</math>          Example:        50 --&gt; 3000K                            100 -&gt; 4000K                            150 --&gt; 5000K</p> <p><i>*CCT overwrites the RGB setting</i></p>
61	0..255	0 - 100	<b>Dimmer of Pixel 9</b> (closed --> open)
62	0..1 2..255	0 - 0.4 0.8 - 100	<p><b>LEE Color Gel of Pixel 9</b>          No effect          Display LEE color gel (full list on page 171)  <i>*LEE Color Gel overwrites both, RGB and CCT</i></p>
63	0 - 3 4 5 6 7 - 255	0 - 1.2 1.6 2.0 2.4 2.7 - 100	<p><b>Strobe of Pixel 9</b>          Off          Random Fast          Random Medium          Random Slow          Variable Strobe (0.4Hz --&gt; 25Hz)</p>
64	0 - 255	0 - 100	<b>Intensity Red of Pixel 10</b> (0% --> 100%)
65	0 - 255	0 - 100	<b>Intensity Green of Pixel 10</b> (0% --> 100%)
66	0 - 255	0 - 100	<b>Intensity Blue of Pixel 10</b> (0% --> 100%)
67	0 - 4 4 - 255	0 - 1.5 1.6-100	<p><b>Color Temperature (CCT) of Pixel 10</b>          No effect          Display color temperature          Formula: <math>CCT = 2000 + 20 * DMX-Value</math>          Example:        50 --&gt; 3000K                            100 -&gt; 4000K                            150 --&gt; 5000K</p> <p><i>*CCT overwrites the RGB setting</i></p>
68	0..255	0 - 100	<b>Dimmer of Pixel 10</b> (closed --> open)
69	0..1 2..255	0 - 0.4 0.8 - 100	<p><b>LEE Color Gel of Pixel 10</b>          No effect          Display LEE color gel (full list on page 171)  <i>*LEE Color Gel overwrites both, RGB and CCT</i></p>
70	0 - 3 4 5 6 7 - 255	0 - 1.2 1.6 2.0 2.4 2.7 - 100	<p><b>Strobe of Pixel 10</b>          Off          Random Fast          Random Medium          Random Slow          Variable Strobe (0.4Hz --&gt; 25Hz)</p>
71	0 - 255	0 - 100	<b>Intensity Red of Pixel 11</b> (0% --> 100%)
72	0 - 255	0 - 100	<b>Intensity Green of Pixel 11</b> (0% --> 100%)
73	0 - 255	0 - 100	<b>Intensity Blue of Pixel 11</b> (0% --> 100%)
74	0 - 4 4 - 255	0 - 1.5 1.6-100	<p><b>Color Temperature (CCT) of Pixel 11</b>          No effect          Display color temperature          Formula: <math>CCT = 2000 + 20 * DMX-Value</math></p>

			<p>Example: 50 --&gt; 3000K 100 -&gt; 4000K 150 --&gt; 5000K</p> <p><i>*CCT overwrites the RGB setting</i></p>
75	0..255	0 - 100	<b>Dimmer of Pixel 11</b> (closed --> open)
76	0..1 2..255	0 - 0.4 0.8 - 100	<p><b>LEE Color Gel of Pixel 11</b></p> <p>No effect</p> <p>Display LEE color gel (full list on page 171)</p> <p><i>*LEE Color Gel overwrites both, RGB and CCT</i></p>
77	0 - 3 4 5 6 7 - 255	0 - 1.2 1.6 2.0 2.4 2.7 - 100	<p><b>Strobe of Pixel 11</b></p> <p>Off</p> <p>Random Fast</p> <p>Random Medium</p> <p>Random Slow</p> <p>Variable Strobe (0.4Hz --&gt; 25Hz)</p>
78	0 - 255	0 - 100	<b>Intensity Red of Pixel 12</b> (0% --> 100%)
79	0 - 255	0 - 100	<b>Intensity Green of Pixel 12</b> (0% --> 100%)
80	0 - 255	0 - 100	<b>Intensity Blue of Pixel 12</b> (0% --> 100%)
81	0 - 4 4 - 255	0 - 1.5 1.6-100	<p><b>Color Temperature (CCT) of Pixel 12</b></p> <p>No effect</p> <p>Display color temperature</p> <p>Formula: <math>CCT = 2000 + 20 * DMX-Value</math></p> <p>Example: 50 --&gt; 3000K 100 -&gt; 4000K 150 --&gt; 5000K</p> <p><i>*CCT overwrites the RGB setting</i></p>
82	0..255	0 - 100	<b>Dimmer of Pixel 12</b> (closed --> open)
83	0..1 2..255	0 - 0.4 0.8 - 100	<p><b>LEE Color Gel of Pixel 12</b></p> <p>No effect</p> <p>Display LEE color gel (full list on page 171)</p> <p><i>*LEE Color Gel overwrites both, RGB and CCT</i></p>
84	0 - 3 4 5 6 7 - 255	0 - 1.2 1.6 2.0 2.4 2.7 - 100	<p><b>Strobe of Pixel 12</b></p> <p>Off</p> <p>Random Fast</p> <p>Random Medium</p> <p>Random Slow</p> <p>Variable Strobe (0.4Hz --&gt; 25Hz)</p>
85	0 - 255	0 - 100	<b>Intensity Red of Pixel 13</b> (0% --> 100%)
86	0 - 255	0 - 100	<b>Intensity Green of Pixel 13</b> (0% --> 100%)
87	0 - 255	0 - 100	<b>Intensity Blue of Pixel 13</b> (0% --> 100%)
88	0 - 4 4 - 255	0 - 1.5 1.6-100	<p><b>Color Temperature (CCT) of Pixel 13</b></p> <p>No effect</p> <p>Display color temperature</p> <p>Formula: <math>CCT = 2000 + 20 * DMX-Value</math></p> <p>Example: 50 --&gt; 3000K 100 -&gt; 4000K</p>

			150 --> 5000K <i>*CCT overwrites the RGB setting</i>
89	0..255	0 - 100	<b>Dimmer of Pixel 13</b> (closed --> open)
90	0..1 2..255	0 - 0.4 0.8 - 100	<b>LEE Color Gel of Pixel 13</b> No effect Display LEE color gel (full list on page 171) <i>*LEE Color Gel overwrites both, RGB and CCT</i>
91	0 - 3 4 5 6 7 - 255	0 - 1.2 1.6 2.0 2.4 2.7 - 100	<b>Strobe of Pixel 13</b> Off Random Fast Random Medium Random Slow Variable Strobe (0.4Hz --> 25Hz)
92	0 - 255	0 - 100	<b>Intensity Red of Pixel 14</b> (0% --> 100%)
93	0 - 255	0 - 100	<b>Intensity Green of Pixel 14</b> (0% --> 100%)
94	0 - 255	0 - 100	<b>Intensity Blue of Pixel 14</b> (0% --> 100%)
95	0 - 4 4 - 255	0 - 1.5 1.6-100	<b>Color Temperature (CCT) of Pixel 14</b> No effect Display color temperature Formula: $CCT = 2000 + 20 * DMX-Value$ Example: 50 --> 3000K 100 -> 4000K 150 --> 5000K <i>*CCT overwrites the RGB setting</i>
96	0..255	0 - 100	<b>Dimmer of Pixel 14</b> (closed --> open)
97	0..1 2..255	0 - 0.4 0.8 - 100	<b>LEE Color Gel of Pixel 14</b> No effect Display LEE color gel (full list on page 171) <i>*LEE Color Gel overwrites both, RGB and CCT</i>
98	0 - 3 4 5 6 7 - 255	0 - 1.2 1.6 2.0 2.4 2.7 - 100	<b>Strobe of Pixel 14</b> Off Random Fast Random Medium Random Slow Variable Strobe (0.4Hz --> 25Hz)
99	0 - 255	0 - 100	<b>Intensity Red of Pixel 15</b> (0% --> 100%)
100	0 - 255	0 - 100	<b>Intensity Green of Pixel 15</b> (0% --> 100%)
101	0 - 255	0 - 100	<b>Intensity Blue of Pixel 15</b> (0% --> 100%)
102	0 - 4 4 - 255	0 - 1.5 1.6-100	<b>Color Temperature (CCT) of Pixel 15</b> No effect Display color temperature Formula: $CCT = 2000 + 20 * DMX-Value$ Example: 50 --> 3000K 100 -> 4000K 150 --> 5000K <i>*CCT overwrites the RGB setting</i>

103	0..255	0 - 100	<b>Dimmer of Pixel 15</b> (closed --> open)
104	0..1 2..255	0 - 0.4 0.8 - 100	<b>LEE Color Gel of Pixel 15</b> No effect Display LEE color gel (full list on page 171) <i>*LEE Color Gel overwrites both, RGB and CCT</i>
105	0 - 3 4 5 6 7 - 255	0 - 1.2 1.6 2.0 2.4 2.7 - 100	<b>Strobe of Pixel 15</b> Off Random Fast Random Medium Random Slow Variable Strobe (0.4Hz --> 25Hz)
106	0 - 255	0 - 100	<b>Intensity Red of Pixel 16</b> (0% --> 100%)
107	0 - 255	0 - 100	<b>Intensity Green of Pixel 16</b> (0% --> 100%)
108	0 - 255	0 - 100	<b>Intensity Blue of Pixel 16</b> (0% --> 100%)
109	0 - 4 4 - 255	0 - 1.5 1.6-100	<b>Color Temperature (CCT) of Pixel 16</b> No effect Display color temperature Formula: $CCT = 2000 + 20 * DMX\text{-Value}$ Example: 50 --> 3000K 100 -> 4000K 150 --> 5000K <i>*CCT overwrites the RGB setting</i>
110	0..255	0 - 100	<b>Dimmer of Pixel 16</b> (closed --> open)
111	0..1 2..255	0 - 0.4 0.8 - 100	<b>LEE Color Gel of Pixel 16</b> No effect Display LEE color gel (full list on page 171) <i>*LEE Color Gel overwrites both, RGB and CCT</i>
112	0 - 3 4 5 6 7 - 255	0 - 1.2 1.6 2.0 2.4 2.7 - 100	<b>Strobe of Pixel 16</b> Off Random Fast Random Medium Random Slow Variable Strobe (0.4Hz --> 25Hz)



## LEE COLOR GELS

CHANNEL	VALUE	PERCENTAGE	FUNCTION
	0..1	0 - 0.4	No effect
	2	0.8	Rose Pink
	3	1.2	Lavender Tint
	4	1.6	Medium Bastard Amber
	7	2.7	Pale Yellow
	8	3.1	Dark Salmon
	9	3.5	Pale Amber Gold
	10	3.9	Medium Yellow
	13	5.1	Straw Tint
	15	5.9	Deep Straw
	17	6.7	Surprise Peach
	19	7.5	Fire
	20	7.8	Medium Amber
	21	8.2	Gold Amber
	22	8.6	Dark Amber
	24	9.4	Scarlet
	25	9.8	Sunset Red
	26	10.2	Bright Red
	27	10.6	Medium Red
	29	11.4	Plasa Red
	35	13.7	Light Pink
	36	14.1	Medium Pink
	46	18.0	Dark Magenta
	48	18.8	Rose Purple
	49	19.2	Medium Purple
	52	20.4	Light Lavender
	53	20.8	Paler Lavender
	58	22.7	Lavender
	61	23.9	Mist Blue
	63	24.7	Pale Blue
	68	26.7	Sky Blue
	71	27.8	Tokyo Blue
	75	29.4	Evening Blue
	79	31.0	Just Blue
	85	33.3	Deeper Blue
	88	34.5	Lime Green
	89	34.9	Moss Green
	90	35.3	Dark Yellow Green
	100	39.2	Spring Yellow
	101	39.6	Yellow
	102	40.0	Light Amber



	103	40.4	Straw
	104	40.8	Deep Amber
	105	41.2	Orange
	106	41.6	Primary Red
	107	42.0	Light Rose
	108	42.4	English Rose
	109	42.7	Light Salmon
	110	43.1	Middle Rose
	111	43.5	Dark Pink
	113	44.3	Magenta
	115	45.1	Peacock Blue
	116	45.5	Medium Blue-Green
	117	45.9	Steel Blue
	118	46.3	Light Blue
	119	46.7	Dark Blue
	120	47.1	Deep Blue
	121	47.5	LEE Green
	122	47.8	Fern Green
	124	48.6	Dark Green
	126	49.4	Mauve
	127	49.8	Smokey Pink
	128	50.2	Bright Pink
	129	50.6	Heavy Frost
	130	51.0	Clear
	131	51.4	Marine Blue
	132	51.8	Medium Blue
	134	52.5	Golden Amber
	135	52.9	Deep Golden Amber
	136	53.3	Pale Lavender
	137	53.7	Special Lavender
	138	54.1	Pale Green
	139	54.5	Primary Green
	140	54.9	Summer Blue
	141	55.3	Bright Blue
	142	55.7	Pale Violet
	143	56.1	Pale Navy Blue
	144	56.5	No Colour Blue
	147	57.6	Apricot
	148	58.0	Bright Rose
	151	59.2	Gold Tint
	152	59.6	Pale Gold
	153	60.0	Pale Salmon
	154	60.4	Pale Rose
	156	61.2	Chocolate



	171	61.6	Pink
	158	62.0	Deep Orange
	159	62.4	No Colour Straw
	161	63.1	Slate Blue
	162	63.5	Bastard Amber
	164	64.3	Flame Red
	165	64.7	Daylight Blue
	169	66.3	Lilac Tint
	171	66.7	Deep Lavender
	172	67.5	Lagoon Blue
	174	68.2	Dark Steel Blue
	176	69.0	Loving Amber
	179	70.2	Chrome Orange
	180	70.6	Dark Lavender
	181	71.0	Congo Blue
	182	71.4	Light Red
	183	71.8	Moonlight Blue
	184	72.2	Cosmetic Peach
	186	72.9	Cosmetic Silver Rose
	187	73.3	Cosmetic Rouge
	188	73.7	Cosmetic Highlight
	189	74.1	Cosmetic Silver Moss
	191	74.9	Cosmetic Aqua Blue
	192	75.3	Flesh Pink
	194	76.1	Surprise Pink
	195	76.5	Zenith Blue
	196	76.9	True Blue
	197	77.3	Alice Blue
	198	77.6	Palace Blue
	199	78.0	Regal Blue
	200	78.4	Double CT Blue
	201	78.8	Full CT Blue
	202	79.2	1/2 CT Blue
	203	79.6	1/4 CT Blue
	204	80.0	Full CT Orange
	205	80.4	1/2 CT Orange
	206	80.8	1/4 CT Orange
	207	81.2	Full CT Orange +
	208	81.6	Full CT Orange +
	209	82.0	0.3 Neutral Density
	210	82.4	0.6 Neutral Density
	211	82.7	0.9 Neutral Density
	212	83.1	LCT Yellow
	213	83.5	Emulated White Flame Green



	216	84.7	Emulated White Diffusion
	217	85.1	Blue Diffusion
	218	85.5	1/8 CT Blue
	219	85.9	LEE Fluorescent Green
	220	86.3	Emulated White Frost
	221	86.7	Blue Frost
	223	87.5	1/8 CT Orange
	224	87.8	Daylight Blue Frost
	225	88.2	LEE N.D. Frost
	226	88.6	LEE U.V.
	228	89.4	Brushed Silk
	229	89.8	1/4 Tough Spun
	230	90.2	Super Correction
	232	91.0	Super Emulated White Flame Green
	236	92.5	H.M.I (To Tungsten)
	237	92.9	C.I.D. (To Tungsten)
	238	93.3	C.S.I. (To Tungsten)
	239	93.7	Polariser
	241	94.5	LEE Fluorescent 5700 K
	242	94.9	LEE Fluorescent 4300 K
	243	95.3	LEE Fluorescent 3600 K
	244	95.7	LEE Plus Green
	245	96.1	1/2 Plus Green
	246	96.5	1/4 Plus Green
	247	96.9	LEE Minus Green
	248	97.3	1/2 Minus Green
	249	97.6	1/4 Minus Green
	250	98.0	1/2 Emulated White Diffusion
	251	98.4	1/4 Emulated White Diffusion
	252	98.8	1/8 Emulated White Diffusion
	253	99.2	Hampshire Frost
	254	99.6	New Hampshire Frost
	255	100.0	Hollywood Frost



## 11 VERSION HISTORY

---

30.09.2018	Initial version
01.11.2018	Revised eyebolt paragraph, added HOT icon, added compatability mode, changed Runtime when on AC